

CENIKA

10/2007

HIGH RUNNER KATALOG



www.cenika.no +47 32 24 03 00
www.cenika.se +46-40-631 55 00



KVALITET TIL MARKEDETS BESTE PRISER
KVALITET TILL MARKNADENS BÄSTA PRISER

Forretningside

Gjennom vår kompetanse, kvalitet og leveringsdyktighet, skal vi levere vernmateriell til installatører, tavlebyggere og industri til markedets beste priser. Vi skal med dette være en markedspartner som opptrer fleksibelt og lyttende ovenfor våre kunder, samt gi de beste relasjoner og muligheter for god inntjening. Norge er vårt hjemmemarked, men vi vil også være representert i Sverige og Danmark gjennom datterselskap.

Affärsidé

Genom vår kompetens, kvalitet og leveransskicklighet, skall vi leverera lågspenningsmateriale till skåpsbyggare, installatör och industri till marknadens bästa priser. Vi skall med detta vara en samarbetspartner som uppträder flexibelt och lyhört inför våra kunder, samt säkerställa god lönsamhet för båda parter. Skandinavien är vår hemmamarknad.

Om Cenika

Cenika er et helnorsk firma som leverer tavleutstyr til den profesjonelle elektrobransjen. Denne katalogen er en oversiktlig highrunner katalog, som skal gjøre det enkelt for deg som kunde å handle av Cenika AS. Bredden vi kan tilby er langt større og vi har egne kataloger for dette. Vi har materiell av topp kvalitet, med full dokumentasjon til markedets desidert beste priser. Alle vern finnes selvfølgelig i FebDok, komplett opptil 6300A.

■ **Cenika AS** har lager og kontorer på Lier i Buskerud, samt dyktige samarbeidspartnere i hele landet som lagerfører våre produkter. Vi kan også tilby våre kunder en netthandel hvor de ved hjelp at et privat brukernavn og passord kan logge seg inn og bestille våre produkter til sine egne rabatterte priser. Våre nye lokaler i Lier huser hovedkontoret til Cenika.

■ Våre selgere har høy bransjekunnskap og produktkunnskap etter mange år i bransjen. Cenika har også egen teknisk avdeling hvor våre kunder kan henvende seg med eventuelle spørsmål de måtte ha relatert til våre produkter.

■ **Cenika AB** är ett nystartat dotterbolag till Cenika AS i Norge. Cenika AB skall handha all försäljning och distribution i Sverige och Danmark. Cenika AB har ett stort lager lokaliserat i Malmö för att sörja för god och tillförlitlig distribution i Sverige och Danmark. Vi kan också erbjuda våra kunder näthandel som är ett enkelt och snabbt sätt att hantera dagliga order. Du som kund får egna inloggningsuppgifter med prislista och leveransvillkor knutna till ditt kundnummer. Cenikas säljare har hög produkt och marknadskunnskap, Cenika skall vara rikstäckande både i Sverige och Danmark.

■ **Chint Group Corporation** ble grunnlagt i 1984 i byen Wenzhou, 40 mil sør for Shanghai. I løpet av de senere år har Chint utviklet seg til å bli verdens 3 største produsent av lavspenningsmateriale. I 2000 ble Chint tildelt National Outstanding Enterprise in Quality Management i Kina, en pris som henger meget høyt. I 2003 hadde Chint 21.000 ansatte. Chint har egne datterselskaper over hele verden, bl.a USA, Tyskland, England, Russland, Brasil og Midt Østen. Cenika fokuserer foreløpig på vern fra Chint, men vi vil utvide vårt sortiment etter hvert. www.chint.com

■ **Klemsan** holder til i Izmir i Tyrkia og har produsert rekkeklemmer og tilbehør siden 1974. ISO 9001 & 14001 sertifisert. Klemsan eksporterer produkter til over 40 land over hele verden, bl.a. USA, Brasil, England, Italia, Russland, Nord Korea og Midt Østen. www.klemsan.com.tr

■ **F-tronic** holder til i Saarbrücken i Tyskland og ble grunnlagt i 1990. Vi fokuserer på deres produktspekter innen skap og tavler. www.f-tronic.de

■ **Saltek** er et tsjekkisk firma som holder til i Praha. Deres produksjon er i sin helhet overspenningsvern. www.saltek.biz/cze/

■ **Relequick** er et innovativt selskap som produserer releér, sokler og solidstate rele i alle størrelser. Relequick har ett av markedets bredeste og mest innovative program på skalerbare releer. Relequick er lokalisert i Toledo i Spania og er 9001 sertifisert. www.relequick.com



Automater

6 ka

NB1 ER EN AV VERDENS MEST SOLGTE AUTOMATSIKRINGER
TILKOBLING FOR BÅDE PIN OG GAFFEL SKINNE PÅ BEGGE SIDER

- EN 60898
- MOMENT = 2 Nm



1-pol



1+N-pol

3-pol

3+N-pol

Merkestrøm	Forpakning	Varenummer	B karakteristikk	Varenummer	C karakteristikk
10 A	12	CV006576	NB1-63/1P-B10	CV007092	NB1-63/1P-C10
13 A	12	CV015738	NB1-63/1P-B13	CV015745	NB1-63/1P-C13
16 A	12	CV006583	NB1-63/1P-B16	CV007108	NB1-63/1P-C16
20 A	12	CV006590	NB1-63/1P-B20	CV007115	NB1-63/1P-C20
25 A	12	CV006606	NB1-63/1P-B25	CV007122	NB1-63/1P-C25
32 A	12	CV006613	NB1-63/1P-B32	CV007139	NB1-63/1P-C32
40 A	12	CV006620	NB1-63/1P-B40	CV007146	NB1-63/1P-C40
50 A	12	CV006637	NB1-63/1P-B50	CV007153	NB1-63/1P-C50
63 A	12	CV006644	NB1-63/1P-B63	CV007160	NB1-63/1P-C63

Merkestrøm	Forpakning	Varenummer	B karakteristikk	Varenummer	C karakteristikk
10 A	6	CV015004	NB1-63/1+N-B10	CV015097	NB1-63/1+N-C10
13 A	6	CV015011	NB1-63/1+N-B13	CV015103	NB1-63/1+N-C13
16 A	6	CV015028	NB1-63/1+N-B16	CV015110	NB1-63/1+N-C16
20 A	6	CV015035	NB1-63/1+N-B20	CV015127	NB1-63/1+N-C20
25 A	6	CV015042	NB1-63/1+N-B25	CV015134	NB1-63/1+N-C25
32 A	6	CV015059	NB1-63/1+N-B32	CV015141	NB1-63/1+N-C32
40 A	6	CV015066	NB1-63/1+N-B40	CV015158	NB1-63/1+N-C40
50 A	6	CV015073	NB1-63/1+N-B50	CV015165	NB1-63/1+N-C50
63 A	6	CV015080	NB1-63/1+N-B63	CV015172	NB1-63/1+N-C63

Merkestrøm	Forpakning	Varenummer	B karakteristikk	Varenummer	C karakteristikk
10 A	4	CV006835	NB1-63/3P-B10	CV007351	NB1-63/3P-C10
13 A	4	CV015752	NB1-63/3P-B13	CV015769	NB1-63/3P-C13
16 A	4	CV006842	NB1-63/3P-B16	CV007368	NB1-63/3P-C16
20 A	4	CV006859	NB1-63/3P-B20	CV007375	NB1-63/3P-C20
25 A	4	CV006866	NB1-63/3P-B25	CV007382	NB1-63/3P-C25
32 A	4	CV006873	NB1-63/3P-B32	CV007399	NB1-63/3P-C32
40 A	4	CV006880	NB1-63/3P-B40	CV007405	NB1-63/3P-C40
50 A	4	CV006897	NB1-63/3P-B50	CV007412	NB1-63/3P-C50
63 A	4	CV006903	NB1-63/3P-B63	CV007429	NB1-63/3P-C63

Merkestrøm	Forpakning	Varenummer	B karakteristikk	Varenummer	C karakteristikk
10 A	4	CV006835	NB1-63/3P-B10	CV007351	NB1-63/3P-C10
13 A	4	CV015752	NB1-63/3P-B13	CV015769	NB1-63/3P-C13
16 A	4	CV006842	NB1-63/3P-B16	CV007368	NB1-63/3P-C16
20 A	4	CV006859	NB1-63/3P-B20	CV007375	NB1-63/3P-C20
25 A	4	CV006866	NB1-63/3P-B25	CV007382	NB1-63/3P-C25
32 A	4	CV006873	NB1-63/3P-B32	CV007399	NB1-63/3P-C32
40 A	4	CV006880	NB1-63/3P-B40	CV007405	NB1-63/3P-C40
50 A	4	CV006897	NB1-63/3P-B50	CV007412	NB1-63/3P-C50
63 A	4	CV006903	NB1-63/3P-B63	CV007429	NB1-63/3P-C63



Automater

10kA

1-pol ▶

Merkestrøm	Forpakning	Varenummer	B karakteristikk	Varenummer	C karakteristikk	Varenummer	D karakteristikk
1 A	12	CV007566	NB1-63H/1P-B1 10 kA	CV007696	NB1-63H/1P-C1 10 kA	CV016261	NB1-63H/1P-D1 10 kA
2 A	12	CV007573	NB1-63H/1P-B2 10 kA	CV007702	NB1-63H/1P-C2 10 kA	CV016278	NB1-63H/1P-D2 10 kA
3 A	12	CV007580	NB1-63H/1P-B3 10 kA	CV007719	NB1-63H/1P-C3 10 kA	CV016285	NB1-63H/1P-D3 10 kA
4 A	12	CV007597	NB1-63H/1P-B4 10 kA	CV007726	NB1-63H/1P-C4 10 kA	CV016292	NB1-63H/1P-D4 10 kA
6 A	12	CV007603	NB1-63H/1P-B6 10 kA	CV007733	NB1-63H/1P-C6 10 kA	CV016308	NB1-63H/1P-D6 10 kA
10 A	12	CV007610	NB1-63H/1P-B10 10 kA	CV007740	NB1-63H/1P-C10 10 kA	CV016315	NB1-63H/1P-D10 10 kA
13 A	12	CV015776	NB1-63H/1P-B13 10 kA	CV009485	NB1-63H/1P-C13 10 kA	CV016322	NB1-63H/1P-D13 10 kA
16 A	12	CV007627	NB1-63H/1P-B16 10 kA	CV007757	NB1-63H/1P-C16 10 kA	CV016339	NB1-63H/1P-D16 10 kA
20 A	12	CV007634	NB1-63H/1P-B20 10 kA	CV007764	NB1-63H/1P-C20 10 kA	CV016346	NB1-63H/1P-D20 10 kA
25 A	12	CV007641	NB1-63H/1P-B25 10 kA	CV007771	NB1-63H/1P-C25 10 kA	CV016353	NB1-63H/1P-D25 10 kA
32 A	12	CV007658	NB1-63H/1P-B32 10 kA	CV007788	NB1-63H/1P-C32 10 kA	CV016361	NB1-63H/1P-D32 10 kA
40 A	12	CV007665	NB1-63H/1P-B40 10 kA	CV007795	NB1-63H/1P-C40 10 kA	CV016377	NB1-63H/1P-D40 10 kA
50 A	12	CV007672	NB1-63H/1P-B50 10 kA	CV007801	NB1-63H/1P-C50 10 kA	CV016384	NB1-63H/1P-D50 10 kA
63 A	12	CV007689	NB1-63H/1P-B63 10 kA	CV007818	NB1-63H/1P-C63 10 kA	CV016391	NB1-63H/1P-D63 10 kA

1+N-pol ▶

Merkestrøm	Forpakning	Varenummer	B karakteristikk	Varenummer	C karakteristikk	Varenummer	D karakteristikk
1 A	6	CV015783	NB1-63H/1+N-B1 10 kA	CV015837	NB1-63H/1+N-C1 10 kA	CV015882	NB1-63H/1+N-D1 10 kA
2 A	6	CV015791	NB1-63H/1+N-B2 10 kA	CV015844	NB1-63H/1+N-C2 10 kA	CV015899	NB1-63H/1+N-D2 10 kA
3 A	6	CV015806	NB1-63H/1+N-B3 10 kA	CV015851	NB1-63H/1+N-C3 10 kA	CV015905	NB1-63H/1+N-D3 10 kA
4 A	6	CV015813	NB1-63H/1+N-B4 10 kA	CV015868	NB1-63H/1+N-C4 10 kA	CV015912	NB1-63H/1+N-D4 10 kA
6 A	6	CV015821	NB1-63H/1+N-B6 10 kA	CV015875	NB1-63H/1+N-C6 10 kA	CV015929	NB1-63H/1+N-D6 10 kA
10 A	6	CV015363	NB1-63H/1+N-B10 10 kA	CV015455	NB1-63H/1+N-C10 10 kA	CV015936	NB1-63H/1+N-D10 10 kA
13 A	6	CV015370	NB1-63H/1+N-B13 10 kA	CV015462	NB1-63H/1+N-C13 10 kA	CV015943	NB1-63H/1+N-D13 10 kA
16 A	6	CV015387	NB1-63H/1+N-B16 10 kA	CV015479	NB1-63H/1+N-C16 10 kA	CV015951	NB1-63H/1+N-D16 10 kA
20 A	6	CV015394	NB1-63H/1+N-B20 10 kA	CV015486	NB1-63H/1+N-C20 10 kA	CV015967	NB1-63H/1+N-D20 10 kA
25 A	6	CV015400	NB1-63H/1+N-B25 10 kA	CV015493	NB1-63H/1+N-C25 10 kA	CV015974	NB1-63H/1+N-D25 10 kA
32 A	6	CV015417	NB1-63H/1+N-B32 10 kA	CV015509	NB1-63H/1+N-C32 10 kA	CV015981	NB1-63H/1+N-D32 10 kA
40 A	6	CV015424	NB1-63H/1+N-B40 10 kA	CV015516	NB1-63H/1+N-C40 10 kA	CV015998	NB1-63H/1+N-D40 10 kA
50 A	6	CV015431	NB1-63H/1+N-B50 10 kA	CV015523	NB1-63H/1+N-C50 10 kA	CV016001	NB1-63H/1+N-D50 10 kA
63 A	6	CV015448	NB1-63H/1+N-B63 10 kA	CV015530	NB1-63H/1+N-C63 10 kA	CV016018	NB1-63H/1+N-D63 10 kA

2-pol ▶

Merkestrøm	Forpakning	Varenummer	B karakteristikk	Varenummer	C karakteristikk	Varenummer	D karakteristikk
1 A	6	CV000017	NB1-63H/2P-B1	CV000406	NB1-63H/2P-C1	CV000796	NB1-63H/2P-D1
2 A	6	CV000024	NB1-63H/2P-B2	CV000413	NB1-63H/2P-C2	CV000802	NB1-63H/2P-D2
3 A	6	CV000031	NB1-63H/2P-B3	CV000420	NB1-63H/2P-C3	CV000819	NB1-63H/2P-D3
4 A	6	CV000048	NB1-63H/2P-B4	CV000437	NB1-63H/2P-C4	CV000826	NB1-63H/2P-D4
6 A	6	CV000055	NB1-63H/2P-B6	CV000444	NB1-63H/2P-C6	CV000833	NB1-63H/2P-D6
10 A	6	CV000062	NB1-63H/2P-B10	CV000451	NB1-63H/2P-C10	CV000840	NB1-63H/2P-D10
13 A	6	CV009966	NB1-63H/2P-B13	CV008075	NB1-63H/2P-C13	CV000857	NB1-63H/2P-D13
16 A	6	CV000079	NB1-63H/2P-B16	CV000468	NB1-63H/2P-C16	CV000864	NB1-63H/2P-D16
20 A	6	CV000086	NB1-63H/2P-B20	CV000475	NB1-63H/2P-C20	CV000871	NB1-63H/2P-D20
25 A	6	CV000093	NB1-63H/2P-B25	CV000482	NB1-63H/2P-C25	CV000888	NB1-63H/2P-D25
32 A	6	CV000109	NB1-63H/2P-B32	CV000499	NB1-63H/2P-C32	CV000895	NB1-63H/2P-D32
40 A	6	CV000116	NB1-63H/2P-B40	CV000505	NB1-63H/2P-C40	CV000901	NB1-63H/2P-D40
50 A	6	CV000123	NB1-63H/2P-B50	CV000512	NB1-63H/2P-C50	CV000918	NB1-63H/2P-D50
63 A	6	CV000130	NB1-63H/2P-B63	CV000529	NB1-63H/2P-C63		



3-pol

Merkestrøm	Forpakning	Varenummer	B karakteristikk	Varenummer	C karakteristikk	Varenummer	D karakteristikk
1 A	4	CV000147	NB1-63H/3P-B1	CV000536	NB1-63H/3P-C1	CV000925	NB1-63H/3P-D1
2 A	4	CV000154	NB1-63H/3P-B2	CV000543	NB1-63H/3P-C2	CV000932	NB1-63H/3P-D2
3 A	4	CV000161	NB1-63H/3P-B3	CV000550	NB1-63H/3P-C3	CV000949	NB1-63H/3P-D3
4 A	4	CV000178	NB1-63H/3P-B4	CV000567	NB1-63H/3P-C4	CV000956	NB1-63H/3P-D4
6 A	4	CV000185	NB1-63H/3P-B6	CV000574	NB1-63H/3P-C6	CV000963	NB1-63H/3P-D6
10 A	4	CV000192	NB1-63H/3P-B10	CV000581	NB1-63H/3P-C10	CV000970	NB1-63H/3P-D10
13 A	4	CV000959	NB1-63H/3P-B13	CV000935	NB1-63H/3P-C13	CV000973	NB1-63H/3P-D13
16 A	4	CV000208	NB1-63H/3P-B16	CV000598	NB1-63H/3P-C16	CV000987	NB1-63H/3P-D16
20 A	4	CV000215	NB1-63H/3P-B20	CV000604	NB1-63H/3P-C20	CV000994	NB1-63H/3P-D20
25 A	4	CV000222	NB1-63H/3P-B25	CV000611	NB1-63H/3P-C25	CV001007	NB1-63H/3P-D25
32 A	4	CV000239	NB1-63H/3P-B32	CV000628	NB1-63H/3P-C32	CV001014	NB1-63H/3P-D32
40 A	4	CV000246	NB1-63H/3P-B40	CV000635	NB1-63H/3P-C40	CV001021	NB1-63H/3P-D40
50 A	4	CV000253	NB1-63H/3P-B50	CV000642	NB1-63H/3P-C50	CV001038	NB1-63H/3P-D50
63 A	4	CV000260	NB1-63H/3P-B63	CV000659	NB1-63H/3P-C63	CV001045	NB1-63H/3P-D63

3+N-pol

Merkestrøm	Forpakning	Varenummer	B karakteristikk	Varenummer	C karakteristikk	Varenummer	D karakteristikk
1 A	3	CV016025	NB1-63H/3+N-B1	CV016071	NB1-63H/3+N-C1	CV016124	NB1-63H/3+N-D1
2 A	3	CV016032	NB1-63H/3+N-B2	CV016087	NB1-63H/3+N-C2	CV016131	NB1-63H/3+N-D2
3 A	3	CV016049	NB1-63H/3+N-B3	CV016094	NB1-63H/3+N-C3	CV016148	NB1-63H/3+N-D3
4 A	3	CV016056	NB1-63H/3+N-B4	CV016101	NB1-63H/3+N-C4	CV016155	NB1-63H/3+N-D4
6 A	3	CV016063	NB1-63H/3+N-B6	CV016117	NB1-63H/3+N-C6	CV016162	NB1-63H/3+N-D6
10 A	3	CV015547	NB1-63H/3+N-B10	CV015639	NB1-63H/3+N-C10	CV016179	NB1-63H/3+N-D10
13 A	3	CV015554	NB1-63H/3+N-B13	CV015646	NB1-63H/3+N-C13	CV016186	NB1-63H/3+N-D13
16 A	3	CV015561	NB1-63H/3+N-B16	CV015653	NB1-63H/3+N-C16	CV016193	NB1-63H/3+N-D16
20 A	3	CV015578	NB1-63H/3+N-B20	CV015660	NB1-63H/3+N-C20	CV016209	NB1-63H/3+N-D20
25 A	3	CV015585	NB1-63H/3+N-B25	CV015677	NB1-63H/3+N-C25	CV016216	NB1-63H/3+N-D25
32 A	3	CV015592	NB1-63H/3+N-B32	CV015684	NB1-63H/3+N-C32	CV016223	NB1-63H/3+N-D32
40 A	3	CV015608	NB1-63H/3+N-B40	CV015691	NB1-63H/3+N-C40	CV016231	NB1-63H/3+N-D40
50 A	3	CV015615	NB1-63H/3+N-B50	CV015707	NB1-63H/3+N-C50	CV016247	NB1-63H/3+N-D50
63 A	3	CV015622	NB1-63H/3+N-B63	CV015714	NB1-63H/3+N-C63	CV016254	NB1-63H/3+N-D63

4-pol

Merkestrøm	Forpakning	Varenummer	B karakteristikk	Varenummer	C karakteristikk	Varenummer	D karakteristikk
1 A	3	CV000277	NB1-63H/4P-B1	CV000666	NB1-63H/4P-C1	CV001052	NB1-63H/4P-D1
2 A	3	CV000284	NB1-63H/4P-B2	CV000673	NB1-63H/4P-C2	CV001069	NB1-63H/4P-D2
3 A	3	CV000291	NB1-63H/4P-B3	CV000680	NB1-63H/4P-C3	CV001076	NB1-63H/4P-D3
4 A	3	CV000307	NB1-63H/4P-B4	CV000697	NB1-63H/4P-C4	CV001083	NB1-63H/4P-D4
6 A	3	CV000314	NB1-63H/4P-B6	CV000703	NB1-63H/4P-C6	CV001090	NB1-63H/4P-D6
10 A	3	CV000321	NB1-63H/4P-B10	CV000710	NB1-63H/4P-C10	CV001106	NB1-63H/4P-D10
13 A	3	CV000950	NB1-63H/4P-B13	CV000942	NB1-63H/4P-C13	CV000980	NB1-63H/4P-D13
16 A	3	CV000338	NB1-63H/4P-B16	CV000727	NB1-63H/4P-C16	CV001113	NB1-63H/4P-D16
20 A	3	CV000345	NB1-63H/4P-B20	CV000734	NB1-63H/4P-C20	CV001120	NB1-63H/4P-D20
25 A	3	CV000352	NB1-63H/4P-B25	CV000741	NB1-63H/4P-C25	CV001137	NB1-63H/4P-D25
32 A	3	CV000369	NB1-63H/4P-B32	CV000758	NB1-63H/4P-C32	CV001144	NB1-63H/4P-D32
40 A	3	CV000376	NB1-63H/4P-B40	CV000765	NB1-63H/4P-C40	CV001151	NB1-63H/4P-D40
50 A	3	CV000383	NB1-63H/4P-B50	CV000772	NB1-63H/4P-C50	CV001168	NB1-63H/4P-D50
63 A	3	CV000390	NB1-63H/4P-B63	CV000789	NB1-63H/4P-C63	CV001175	NB1-63H/4P-D63



Tilbehør Automatsikringer og jordfeilautomater/
Tilbehør automatsikringer og jordfelsautomater

Forpakning	Varenummer	Beskrivelse
1	CV005494	AL/CU KLEMME 16-50mm ²
1	CV004909	Hjelpkontakt XF9 AC 415 3A for NB1
1	CV004916	Hjelpkontakt XF9 AC 240 6A for NB1
1	CV004923	Hjelpkontakt XF9 DC 130 1A for NB1
1	CV004930	Hjelpkontakt XF9 DC 48 3A for NB1
1	CV004947	Hjelpkontakt XF9 DC 24 6A for NB1
1	CV004954	Shunttrip S9 AC 230 for NB1
1	CV004961	Shunttrip S9 AC 400 for NB1
1	CV004978	Shunttrip S9 DC 24 for NB1
1	CV004985	Shunttrip S9 DC 48 for NB1
1	CV004992	Shunttrip S9 AC 24 for NB1
1	CV005005	Underspenningsutløser AC 230 for NB1
1	CV005012	Underspenningsutløser AC 24 for NB1



Overlastvern/ Överlastskydd

- IHHT NEK400
- BRUKES MED AL/CU KLEMMER VED AL KABLER
- 10 KA IHHT EN60898

Merkestrøm	Forpakning	Varenummer	2 Pol	Varenummer	3 Pol	Varenummer	4 Pol
25 A	6/4/3	CV001182	NB1-63H/2P-OV25	CV001236	NB1-63H/3P-OV25	CV001281	NB1-63H/4P-OV25
32 A	6/4/3	CV001199	NB1-63H/2P-OV32	CV001243	NB1-63H/3P-OV32	CV001298	NB1-63H/4P-OV32
40 A	6/4/3	CV001205	NB1-63H/2P-OV40	CV001250	NB1-63H/3P-OV40	CV001304	NB1-63H/4P-OV40
50 A	6/4/3	CV001212	NB1-63H/2P-OV50	CV001267	NB1-63H/3P-OV50	CV001311	NB1-63H/4P-OV50
63A	6/4/3	CV001229	NB1-63H/2P-OV63	CV001274	NB1-63H/3P-OV63	CV001328	NB1-63H/4P-OV63



Lastbryter/ Lastbrytare

Merkestrøm	Forpakning	Varenummer	2 Pol	Ant poler
32 A	12	CV008082	NH9-32A 1 MODUL MED LÅS	2 Pol
63 A	12	CV016407	NH4-100-1P-63A	1 Pol
100 A	12	CV016414	NH4-100-1P-100A	1 Pol
63 A	6	CV001335	NH4-100-2P-63A	2 Pol
100 A	6	CV009164	NH4-100-2P-100A	2 Pol
63 A	4	CV001342	NH4-100-3P-63A	3 Pol
100 A	4	CV009171	NH4-100-3P-100A	3 Pol
63 A	3	CV001359	NH4-100-4P-63A	4 Pol
100 A	3	CV001359	NH4-100-4P-63A	4 Pol



Jordfeilautomater/ Jordfelsautomater

- 6KA / 10KA EN60898
- A-TYPE
- FYSISK SKILLE PÅ JORDFEIL/KORTSLUTNING
- 2 MODULER 1+N OG 3 MODULER FOR 2 POL



**1+ N Pol
6 kA
2 moduler**

Merkestrøm	Forpakning	Varenummer	B karakteristikk	Varenummer	C karakteristikk
6 A	1	CV004190	NB1-L40/1+N-B6-30mA	CV001366	NB1-L40/1+N-C6-30mA
10 A	1	CV004206	NB1-L40/1+N-B10-30mA	CV001373	NB1-L40/1+N-C10-30mA
13 A	1	CV009997	NB1-L40/1+N-B13-30mA	CV010009	NB1-L40/1+N-C13-30mA
16 A	1	CV004213	NB1-L40/1+N-B16-30mA	CV001380	NB1-L40/1+N-C16-30mA
20 A	1	CV004220	NB1-L40/1+N-B20-30mA	CV001397	NB1-L40/1+N-C20-30mA
25 A	1	CV004237	NB1-L40/1+N-B25-30mA	CV001403	NB1-L40/1+N-C25-30mA

**1+ N Pol
10 kA
2 moduler**

Merkestrøm	Forpakning	Varenummer	B karakteristikk	Varenummer	C karakteristikk
6 A	1	CV004190	NB1-L40H/1+N-B6-30mA 10 kA	CV001366	NB1-L40H/1+N-C6-30mA 10 kA
10 A	1	CV004206	NB1-L40H/1+N-B10-30mA 10 kA	CV001373	NB1-L40H/1+N-C10-30mA 10 kA
13 A	1	CV009997	NB1-L40H/1+N-B13-30mA 10 kA	CV010009	NB1-L40H/1+N-C13-30mA 10 kA
16 A	1	CV004213	NB1-L40H/1+N-B16-30mA 10 kA	CV001380	NB1-L40H/1+N-C16-30mA 10 kA
20 A	1	CV004220	NB1-L40H/1+N-B20-30mA 10 kA	CV001397	NB1-L40H/1+N-C20-30mA 10 kA
25 A	1	CV004237	NB1-L40H/1+N-B25-30mA 10 kA	CV001403	NB1-L40H/1+N-C25-30mA 10 kA

**2 Pol
10 kA
3 moduler**

Merkestrøm	Forpakning	Varenummer	B karakteristikk	Varenummer	C karakteristikk
6 A	1	CV009324	NB1-L40/2P-B6-30mA	CV009393	NB1-L40/2P-C6-30mA
10 A	1	CV009331	NB1-L40/2P-B10-30mA	CV009409	NB1-L40/2P-C10-30mA
13 A	1	CV009577	NB1-L40/2P-B13-30mA	CV009416	NB1-L40/2P-C13-30mA
16 A	1	CV009348	NB1-L40/2P-B16-30mA	CV009423	NB1-L40/2P-C16-30mA
20 A	1	CV009355	NB1-L40/2P-B20-30mA	CV009430	NB1-L40/2P-C20-30mA
25 A	1	CV009362	NB1-L40/2P-B25-30mA	CV009447	NB1-L40/2P-C25-30mA
32 A	1	CV009379	NB1-L40/2P-B32-30mA	CV009454	NB1-L40/2P-C32-30mA
40 A	1	CV009386	NB1-L40/2P-B40-30mA	CV009461	NB1-L40/2P-C40-30mA

**3 Pol
10 kA
6 moduler**

Merkestrøm	Forpakning	Varenummer	B karakteristikk	Varenummer	C karakteristikk
6 A	1	CV004336	NB1-L40/3P-B6-30mA	CV009393	NB1-L40/2P-C6-30mA
10 A	1	CV004343	NB1-L40/3P-B10-30mA	CV009409	NB1-L40/2P-C10-30mA
13 A	1	CV010016	NB1-L40/3P-B13-30mA	CV009416	NB1-L40/2P-C13-30mA
16 A	1	CV004350	NB1-L40/3P-B16-30mA	CV009423	NB1-L40/2P-C16-30mA
20 A	1	CV004367	NB1-L40/3P-B20-30mA	CV009430	NB1-L40/2P-C20-30mA
25 A	1	CV004374	NB1-L40/3P-B25-30mA	CV009447	NB1-L40/2P-C25-30mA
32 A	1	CV004381	NB1-L40/3P-B32-30mA	CV009454	NB1-L40/2P-C32-30mA
40 A	1	CV004398	NB1-L40/3P-B40-30mA	CV009461	NB1-L40/2P-C40-30mA

**4 Pol
10 kA
7 moduler**

Merkestrøm	Forpakning	Varenummer	B karakteristikk	Varenummer	C karakteristikk
6 A	1	CV004473	NB1-L40/4P-B6-30mA	CV001649	NB1-L40/4P-C6-30mA
10 A	1	CV004480	NB1-L40/4P-B10-30mA	CV001656	NB1-L40/4P-C10-30mA
13 A	1	CV010030	NB1-L40/4P-B13-30mA	CV010047	NB1-L40/4P-C13-30mA
16 A	1	CV004497	NB1-L40/4P-B16-30mA	CV001663	NB1-L40/4P-C16-30mA
20 A	1	CV004503	NB1-L40/4P-B20-30mA	CV001670	NB1-L40/4P-C20-30mA
25 A	1	CV004510	NB1-L40/4P-B25-30mA	CV001687	NB1-L40/4P-C25-30mA
32 A	1	CV004527	NB1-L40/4P-B32-30mA	CV001694	NB1-L40/4P-C32-30mA
40 A	1	CV004534	NB1-L40/4P-B40-30mA	CV001700	NB1-L40/4P-C40-30mA



Jordfeilbrytere/ Jordfelsbrytare

- EN 61008
- 10 KA
- A KLASSE

Merkestrøm	Forpakning	Varenummer	2 Pol	Varenummer	4 Pol
40A 30mA	1	CV001724	NL1-63/2P-40A/0.03A	CV001816	NL1-63/4P-40A/0.03A
63A 30mA	1	CV001731	NL1-63/2P-63A/0.03A	CV001823	NL1-63/4P-63A/0.03A
40A 100mA	1	CV001755	NL1-63/2P-40A/0.1A	CV001847	NL1-63/4P-40A/0.1A
63A 100mA	1	CV001762	NL1-63/2P-63A/0.1A	CV001854	NL1-63/4P-63A/0.1A
40A 300mA	1	CV001786	NL1-63/2P-40A/0.3A	CV001878	NL1-63/4P-40A/0.3A
63A 300mA	1	CV001793	NL1-63/2P-63A/0.3A	CV001885	NL1-63/4P-63A/0.3A

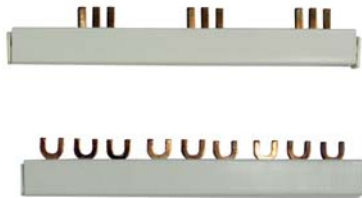

Samleskinner/ Samlingssskenor

Jordfeilautomater 2 pol

Mating	Forpakning	Varenummer	Type	Endekappe/Ändavslut
2 Pol	1	CV009492	BUSBAR-2P-RCBO-2P PIN	CV001960
3 Pol	1	CV009508	BUSBAR-3P-RCBO-2P PIN	CV001977
4 Pol	1	CV009515	BUSBAR-4P-RCBO-2P PIN	CV001984
2 Pol	1	CV2221236	BUSBAR-2P-RCBO-2P 16mm2-FORK	CV1310422
3 Pol	1	CV2221399	BUSBAR-3P-RCBO-2P 16mm2-FORK	CV1310422

Jordfeilautomater 3 Pol

Mating	Forpakning	Varenummer	Type	Endekappe/Ändavslut
3 Pol	1	CV001953	BUSBAR-3P-RCBO-3P PIN	CV001977

Jordfeilautomater 4 Pol

Mating	Forpakning	Varenummer	Type	Endekappe/Ändavslut
4 Pol	1	CV005326	BUSBAR-4P-RCBO-4P 16mm2-PIN	CV001984

Automater 1P, 1+N og 2 pol, Jordfeilautomat 1+N

Mating	Forpakning	Varenummer	Type	Endekappe/Ändavslut
2 Pol	1	CV001892	BUSBAR-2P-MCB FORK	CV001960
3 Pol	1	CV001908	BUSBAR-3P-MCB FORK	CV001977
4 Pol	1	CV001915	BUSBAR-4P-MCB-L1-N-L2-N-L3-N FORK	CV001984
2 Pol	1	CV2221202	BUSBAR-2P-MCB 16mm2-PIN	CV1310422
3 Pol	1	CV2221203	BUSBAR-3P-MCB 16mm2-PIN	CV1310422
4 Pol	1	CV2223444	BUSBAR-4P-MCB-L1-N-L2-N-L3-N 16mm2-PIN	CV1310419

Automater 3 Pol

Mating	Forpakning	Varenummer	Type	Endekappe/Ändavslut
3 Pol	1	CV001908	BUSBAR-3P-MCB FORK	CV001977
3 Pol	1	CV2221203	BUSBAR-3P-MCB 16mm2-PIN	CV1310422

Automater 4 Pol

Mating	Forpakning	Varenummer	Type	Endekappe/Ändavslut
4 Pol	1	CV001922	BUSBAR-4P-MCB-4P FORK	CV001984
4 Pol	1	CV2223403	BUSBAR-4P-MCB-4P 16mm2-PIN	CV1310422

Endekapper/Ändavslut/ berøringsbeskyttelse

Mating	Forpakning	Varenummer	Beskrivelse
2 Pol	10	CV001960	ENDCAP-BUSBAR-2P 10mm2
3 Pol	10	CV001977	ENDCAP-BUSBAR-3P 10mm2
4 Pol	10	CV001984	ENDCAP-BUSBAR-4P 10mm2
2 Pol	10	CV1310422	ENDCAP-BUSBAR-2P/3P 16mm2
3 Pol	10	CV1310422	ENDCAP-BUSBAR-2P/3P 16mm2
4 Pol	10	CV1310419	ENDCAP-BUSBAR-4P 16mm2
	10	CV008198	PROTECTION CAP



Överspenningsvern/ Överspänningskydd

VI LAGERFÖRER ET BREDT SPEKTER AV ÖVERSPENNINGSVERN.
HER ER ET UTDRAK.



KLASSE 1 (B/GROVVERN)

- MAKS FORANKOBLET SIKRING 125A
- (8/20) = 30 KA
- (10/350) = 7 KA
- EN 61643-11

Mating	Forpakning	Varenummer	Beskrivelse
3 Pol	1	CV009249	FLP-275 V/3 S RELÉ
4 Pol	1	CV009256	FLP-275 V/4 S RELÉ

KLASSE 1+2 (B+C/GROV OG MELLOMVERN)

- MAKS FORANKOBLET SIKRING 250A
- (8/20) = 30 KA
- (10/350) = 20 KA
- EN 61643-11

Mating	Forpakning	Varenummer	Beskrivelse
3 Pol	1	CV006477	FLP-B+C-GE 3 POLE
4 Pol	1	CV006484	FLP-B+C-GE 4 POLE



KLASSE 2 (C /MELLOMVERN)

- MAKS FORANKOBLET SIKRING 100A
- (8/20) = 20/40 KA
- EN 61643-11

Mating	Forpakning	Varenummer	Beskrivelse
1 Pol	1	CV010092	SLP-275-V/1 U/RELÉ
2 Pol	1	CV001991	SLP-275-V/2 U/RELÉ
3 Pol	1	CV002004	SLP-275-V/3 U/RELÉ
4 Pol	1	CV002011	SLP-275-V/4 U/RELÉ
1 Pol	1	CV010108	SLP-275-V/1 S RELÉ
2 Pol	1	CV002035	SLP-275-V/2 S RELÉ
3 Pol	1	CV002042	SLP-275-V/3 S RELÉ
4 Pol	1	CV002059	SLP-275-V/4 S RELÉ
1 Pol	1	CV002028	SLP-275-REPLACE-MODUL 275V



KLASSE 3 (D / FINVERN)

- MAKS FORANKOBLET SIKRING 16 A
- (8/20) = 3/5 KA
- SIGNAL LAMPE VED FEIL
- EN 61643-11

Mating	Forpakning	Varenummer	Beskrivelse
2 Pol	1	CV006460	DA-275 D)



Effektbrytere/ Effektbrytare

TERMOMAGNETISKE (16-250 A)

- EN 60947
- ICU = 50KA/400V
- VI LAGERFØRER OG ICU=100KA OG 150KA /400V
- INNSTILBAR 0,8 - 1 X IN
- LEVERES MED STANDARD KLEMMER

3 POL 16-125 A

Merkestrøm	Forpakning	Varenummer	Beskrivelse
16 A	1	CV002080	NM8-125S-16A/3P
20 A	1	CV002097	NM8-125S-20A/3P
25 A	1	CV002103	NM8-125S-25A/3P
32 A	1	CV002110	NM8-125S-32A/3P
40 A	1	CV002127	NM8-125S-40A/3P
50 A	1	CV002134	NM8-125S-50A/3P
63 A	1	CV002141	NM8-125S-63A/3P
80 A	1	CV002158	NM8-125S-80A/3P
100 A	1	CV002165	NM8-125S-100A/3P
125 A	1	CV002172	NM8-125S-125A/3P

3 POL 100-250A

Merkestrøm	Forpakning	Varenummer	Beskrivelse
100 A	1	CV002189	NM8-250S-100A/3P
125 A	1	CV002196	NM8-250S-125A/3P
160 A	1	CV002202	NM8-250S-160A/3P
200 A	1	CV002219	NM8-250S-200A/3P
250 A	1	CV002226	NM8-250S-250A/3P



4 POL 16-125A

Merkestrøm	Forpakning	Varenummer	Beskrivelse
16 A	1	CV002332	NM8-125S-16A/4P
20 A	1	CV002349	NM8-125S-20A/4P
25 A	1	CV002356	NM8-125S-25A/4P
32 A	1	CV002363	NM8-125S-32A/4P
40 A	1	CV002370	NM8-125S-40A/4P
50 A	1	CV002387	NM8-125S-50A/4P
63 A	1	CV002394	NM8-125S-63A/4P
80 A	1	CV002400	NM8-125S-80A/4P
100 A	1	CV002417	NM8-125S-100A/4P
125 A	1	CV002424	NM8-125S-125A/4P

4 POL 100-250A

Merkestrøm	Forpakning	Varenummer	Beskrivelse
100 A	1	CV002431	NM8-250S-100A/4P
125 A	1	CV002448	NM8-250S-125A/4P
160 A	1	CV002455	NM8-250S-160A/4P
200 A	1	CV002462	NM8-250S-200A/4P
250 A	1	CV002479	NM8-250S-250A/4P





Effektbrytere/ Effektbrytare

ELEKTRONISKE VERN (20-1250A)

- EN 60947
- ICU = 50KA/400V
- LAGERFØRES OG I ICU = 150 KA
- INNSTILBAR 0,4 - 1 X IN

3-POL

Merkestrøm	Forpakning	Varenummer	Beskrivelse
25 A	1	CV005043	NM8S-125S-25A/3P
40 A	1	CV002851	NM8S-125S-40A/3P
63 A	1	CV005081	NM8S-125S-63A/3P
125 A	1	CV002585	NM8S-125S-125A/3P
160 A	1	CV009522	NM8S-125S-160A/3P
250 A	1	CV002592	NM8S-250S-250A/3P
400 A	1	CV002608	NM8S-400S-400A/3P
630 A	1	CV002615	NM8S-630S-630A/3P
800 A	1	CV002622	NM8S-800S-800A/3P
1250 A	1	CV002639	NM8S-1250S-1250A/3P

4-POL

Merkestrøm	Forpakning	Varenummer	Beskrivelse
25 A	1	CV005135	NM8S-125S-25A/4P
40 A	1	CV002905	NM8S-125S-40A/4P
63 A	1	CV005173	NM8S-125S-63A/4P
125 A	1	CV002646	NM8S-125S-125A/4P
160 A	1	CV009539	NM8S-125S-160A/4P
250 A	1	CV002653	NM8S-250S-250A/4P
400 A	1	CV002660	NM8S-400S-400A/4P
630 A	1	CV002677	NM8S-630S-630A/4P
800 A	1	CV002684	NM8S-800S-800A/4P
1250 A	1	CV002691	NM8S-1250S-1250A/4P



Tilbehør Effektbrytere/ Tillbehör Effektbrytare

SERIE NM8 125

Forpakning Varenummer Beskrivelse

1	CV003049	DIN-MONTASJESETT NM8-125A-3P
1	CV003056	DIN-MONTASJESETT NM8-125A-4P
1	CV010320	KABELKLEMME NM8 125 1 x 50 mm2
1	CV010245	KABELKLEMME CU/AL NM8 125 1 x 35-95mm2
1	CV003896	HÅNDTAK DIREKTEMONTERT NM8-125
1	CV003926	HÅNDTAK DØRMONTERT NM8-125
1	CV003957	NM8-125 MOTOR 220V AC/DC
1	CV003827	NM8-125 SHUNT RELEASE 220V AC
1	CV003858	NM8-125 UNDERSPENNINGSLØSER 220V AC
1	CV003872	HJELPE / ALARM KONTAKTSETT NM8 125-630
1	CV005586	LANGT TERMINALDEKSEL NM8-125 3P 2 STK
1	CV005593	LANGT TERMINALDEKSEL NM8-125 4P 2 STK
1	CV005609	KORT TERMINALDEKSEL NM8-125 3P 2 STK
1	CV005616	KORT TERMINALDEKSEL NM8-125 4P 2 STK
1	CV005500	NM8 125 LÅS

SERIE NM8 250 / NM8S 125

Forpakning Varenummer Beskrivelse

1	CV003063	DIN-MONTASJESETT NM8-250A-3P
1	CV003070	DIN-MONTASJESETT NM8-250A-4P
1	CV010252	KABELKLEMME CU/AL NM8 250/ NM8S 125 1 x 35-120 mm2
1	CV010269	KABELKLEMME CU/AL NM8 250/ NM8S 125 2 x 35-150 mm2
1	CV010276	KABELKLEMME CU/AL NM8 250/ NM8S 125 1 x 120-240 mm2
1	CV003902	HÅNDTAK DIREKTEMONTERT NM8-250
1	CV003933	HÅNDTAK DØRMONTERT NM8-250
1	CV003964	NM8-250 MOTOR 220V AC/DC
1	CV003834	NM8-250/630 SHUNT RELEASE 220V AC
1	CV003865	NM8-250/630 UNDERSPENNINGSLØSER 220V AC
1	CV003872	HJELPE / ALARM KONTAKTSETT NM8 125-630
1	CV005722	LANGT TERMINALDEKSEL NM8-250 3P 2 STK
1	CV005739	LANGT TERMINALDEKSEL NM8-250 4P 2 STK
1	CV005746	KORT TERMINALDEKSEL NM8-250 3P 2 STK
1	CV005753	KORT TERMINALDEKSEL NM8-250 4P 2 STK
1	CV007955	NM8 250 LÅS

SERIE NM8 630 / 400

Forpakning Varenummer Beskrivelse

1	CV010283	KABELKLEMME CU/AL NM8S 630 1 x 240 mm2
1	CV010290	KABELKLEMME CU/AL NM8S 630 2 x 240 mm2
1	CV003919	HÅNDTAK DIREKTEMONTERT NM8-400/630
1	CV003940	HÅNDTAK DØRMONTERT NM8-400/630
1	CV003971	NM8-400/630 MOTOR 220V AC/DC
1	CV003834	NM8-250/630 SHUNT RELEASE 220V AC
1	CV003865	NM8-250/630 UNDERSPENNINGSLØSER 220V AC
1	CV003872	HJELPE / ALARM KONTAKTSETT NM8 125-630
1	CV005807	LANGT TERMINALDEKSEL NM8-400/630 3P 2 STK
1	CV005814	LANGT TERMINALDEKSEL NM8-400/630 4P 2 STK
1	CV005821	KORT TERMINALDEKSEL NM8-400/630 3P 2 STK
1	CV005838	KORT TERMINALDEKSEL NM8-400/630 4P 2 STK
1	CV007962	NM8 630 LÅS

SERIE NM8 1250 / 800

Forpakning Varenummer Beskrivelse

1	CV010306	KABELKLEMME CU/AL NM8S 1250 3 x 240 mm2
1	CV010313	KABELKLEMME CU/AL NM8S 1250 4 x 240 mm2
1	CV003988	NM8-800/1250 MOTOR 220V AC/DC
1	CV003841	NM8-800/1250 SHUNT RELEASE 220 V AC
1	CV005883	NM8-800/1250 UNDERSPENNINGSLØSER 220V AC
1	CV009645	KORT TERMINALDEKSEL NM8-800/1250 3P 2 STK
1	CV009652	KORT TERMINALDEKSEL NM8-800/1250 4P 2 STK



Effektbrytare/ Effektbrytare

(1250 - 6300A)

- EN 60947
- ICU = 80 KA/400V NA1-2000
- ICU = 100 KA/400V NA1-3200/NA1-4000
- ICU = 120 KA/400V NA1-6300
- INNSTILLBAR 0,4 - 1 X IN

3-POL STANDARD

Merkestrøm	Forpakning	Varenummer	Beskrivelse
1250 A	1	CV003087	NA1-2000/1250A-3P
1600 A	1	CV003094	NA1-2000/1600A-3P
2000 A	1	CV003100	NA1-2000/2000A-3P
2500 A	1	CV003124	NA1-3200/2500A-3P
3200 A	1	CV003131	NA1-3200/3200A-3P
4000 A	1	CV003155	NA1-4000/4000A-3P
5000 A	1	CV003179	NA1-6300/5000A-3P
6300 A	1	CV003186	NA1-6300/6300A-3P

4-POL STANDARD

Merkestrøm	Forpakning	Varenummer	Beskrivelse
1250 A	1	CV003193	NA1-2000/1250A-4P
1600 A	1	CV003209	NA1-2000/1600A-4P
2000 A	1	CV003216	NA1-2000/2000A-4P
2500 A	1	CV003230	NA1-3200/2500A-4P
3200 A	1	CV003247	NA1-3200/3200A-4P
4000 A	1	CV003261	NA1-4000/4000A-4P
5000 A	1	CV003285	NA1-6300/5000A-4P
6300 A	1	CV003292	NA1-6300/6300A-4P

3 POL PLUGGBARE/MOTOR

Merkestrøm	Forpakning	Varenummer	Beskrivelse
1600 A	1	CV008228	NA1-2000/1600A-3P MOTOR DRAWER
1600 A	1	CV008235	NA1-2000/1600A-3P MOTOR FIXED
1600 A	1	CV008242	NA1-2000/1600A-3P MANUAL DRAWER
2000 A	1	CV008259	NA1-2000/2000A-3P MOTOR DRAWER
2000 A	1	CV008266	NA1-2000/2000A-3P MOTOR FIXED
2000 A	1	CV008273	NA1-2000/2000A-3P MANUAL DRAWER
2500 A	1	CV008280	NA1-3200/2500A-3P MOTOR DRAWER
2500 A	1	CV008297	NA1-3200/2500A-3P MOTOR FIXED
2500 A	1	CV008303	NA1-3200/2500A-3P MANUAL DRAWER

4-POL PLUGGBARE/MOTOR

Merkestrøm	Forpakning	Varenummer	Beskrivelse
1600 A	1	CV008341	NA1-2000/1600A-4P MOTOR DRAWER
1600 A	1	CV008358	NA1-2000/1600A-4P MOTOR FIXED
1600 A	1	CV008365	NA1-2000/1600A-4P MANUAL DRAWER
2000 A	1	CV008372	NA1-2000/2000A-4P MOTOR DRAWER
2000 A	1	CV008389	NA1-2000/2000A-4P MOTOR FIXED
2000 A	1	CV008396	NA1-2000/2000A-4P MANUAL DRAWER
2500 A	1	CV008402	NA1-3200/2500A-4P MOTOR DRAWER
2500 A	1	CV008419	NA1-3200/2500A-4P MOTOR FIXED
2500 A	1	CV008426	NA1-3200/2500A-4P MANUAL DRAWER





Pluggbare Effektbrytere/ Pluggin Effektbrytare

TERMOMAGNETISKE VERN (20-250A)

- EN 60947 ■ ICU = 50KA/400V ■ INNSTILBAR 0,8 - 1 X IN
- VI LAGERFØRER OG ICU=100KA OG 150KA /400V

3-POL PLUGGBARE/PLUGGIN

Merkestrøm	Forpakning	Varenummer	Beskrivelse
20 A	1	CV008471	NM8-125S-20A/3P PLUGGABLE
32 A	1	CV008488	NM8-125S-32A/3P PLUGGABLE
40 A	1	CV008495	NM8-125S-40A/3P PLUGGABLE
50 A	1	CV008501	NM8-125S-50A/3P PLUGGABLE
63 A	1	CV008518	NM8-125S-63A/3P PLUGGABLE
80 A	1	CV008525	NM8-125S-80A/3P PLUGGABLE
100 A	1	CV008532	NM8-125S-100A/3P PLUGGABLE
125 A	1	CV008549	NM8-125S-125A/3P PLUGGABLE
160 A	1	CV008556	NM8-250S-160A/3P PLUGGABLE
200 A	1	CV008563	NM8-250S-200A/3P PLUGGABLE
250 A	1	CV008570	NM8-250S-250A/3P PLUGGABLE

4-POL PLUGGBARE/PLUGGIN

Merkestrøm	Forpakning	Varenummer	Beskrivelse
20 A	1	CV008587	NM8-125S-20A/4P PLUGGABLE
32 A	1	CV008594	NM8-125S-32A/4P PLUGGABLE
40 A	1	CV008600	NM8-125S-40A/4P PLUGGABLE
50 A	1	CV008617	NM8-125S-50A/4P PLUGGABLE
63 A	1	CV008624	NM8-125S-63A/4P PLUGGABLE
80 A	1	CV008631	NM8-125S-80A/4P PLUGGABLE
100 A	1	CV008648	NM8-125S-100A/4P PLUGGABLE
125 A	1	CV008655	NM8-125S-125A/4P PLUGGABLE
160 A	1	CV008662	NM8-250S-160A/4P PLUGGABLE
200 A	1	CV008679	NM8-250S-200A/4P PLUGGABLE
250 A	1	CV008686	NM8-250S-250A/4P PLUGGABLE
		CV002479	NM8-250S-250A/4P

ELEKTRONISKE VERN (20 - 1250A)

- EN 60947 ■ ICU = 50KA/400V ■ LAGERFØRES OG I ICU = 150 KA
- INNSTILBAR 0,4 - 1 X IN

3-POL PLUGGBARE/PLUGGIN

Merkestrøm	Forpakning	Varenummer	Beskrivelse
25 A	1	CV008693	NM8S-125S-25A/3P PLUGGABLE
63 A	1	CV008709	NM8S-125S-63A/3P PLUGGABLE
125 A	1	CV008716	NM8S-125S-125A/3P PLUGGABLE
250 A	1	CV008723	NM8S-250S-250A/3P PLUGGABLE
400 A	1	CV008730	NM8S-400S-400A/3P PLUGGABLE
630 A	1	CV008747	NM8S-630S-630A/3P PLUGGABLE

4-POL PLUGGBARE/PLUGGIN

Merkestrøm	Forpakning	Varenummer	Beskrivelse
25 A	1	CV008754	NM8S-125S-25A/4P PLUGGABLE
40 A	1	CV008761	NM8S-125S-63A/4P PLUGGABLE
63 A	1	CV008778	NM8S-125S-125A/4P PLUGGABLE
125 A	1	CV008785	NM8S-250S-250A/4P PLUGGABLE
160 A	1	CV008792	NM8S-400S-400A/4P PLUGGABLE
250 A	1	CV008808	NM8S-630S-630A/4P PLUGGABLE

SOKKEL FOR PLUGGBARE/PLUGGIN EFFEKTBRYTERE

- 690V ■ 63-630A ■ IEC 60947-3

3-POL

Merkestrøm	Forpakning	Varenummer	Beskrivelse
125 A	1	CV010160	SOKKEL FOR NM8 125 3 P
250A	1	CV010177	SOKKEL FOR NM8S-125 / NM8 250 3 P
630A	1	CV010184	SOKKEL FOR NM8 630 3 P
1250A	1	CV010191	SOKKEL FOR NM8 1250 3 P

4-POL

Merkestrøm	Forpakning	Varenummer	Beskrivelse
125 A	1	CV010207	SOKKEL FOR NM8 125 4 P
250A	1	CV010214	SOKKEL FOR NM8S-125 / NM8 250 4 P
630A	1	CV010221	SOKKEL FOR NM8 630 4 P
1250A	1	CV010238	SOKKEL FOR NM8 1250 4 P





Kontakter

9-95A

- EN 60947
- OPPTIL 1000V
- 3 POL MED MELDEKONTAKT
- MERKESTRØM I AC3 400V

3-POL

Merkestrøm	Forpakning	Varenummer	Beskrivelse
12 A	5	CV003315	NC1-1210
18 A	1	CV003322	NC1-1810
25 A	1	CV003339	NC1-2510
32 A	1	CV003346	NC1-3210
40 A	1	CV003353	NC1-4011
50 A	1	CV003360	NC1-5011
65 A	1	CV003377	NC1-6511
80 A	1	CV003384	NC1-8011
95 A	1	CV003391	NC1-9511

4-POL

Merkestrøm	Forpakning	Varenummer	Beskrivelse
12 A	5	CV003414	NC1-1204
25 A	1	CV003421	NC1-2504
40 A	1	CV003438	NC1-4004
50 A	1	CV003445	NC1-5004
65 A	1	CV003452	NC1-6504
80 A	1	CV003469	NC1-8004
95 A	1	CV003476	NC1-9504

MODULÆRKONTAKTORER/NORMKONTAKTORER

- EN 61095

Merkestrøm	Forpakning	Varenummer	Beskrivelse
20 A	12	CV003483	NCH8-20-2pol
63 A	3	CV003490	NCH8-63-4pol

MINIKONTAKTORER

- EN 60947
- VERDIER I AC3 400V
- OPPTIL 690V

Merkestrøm	Forpakning	Varenummer	Beskrivelse
9 A	12	CV008839	NC6-0910 230V AC 3 pole
9 A	12	CV008846	NC6-0910 24V AC 3 pole
9 A	12	CV008853	NC6-0904 230V AC 4 pole
9 A	12	CV008860	NC6-0904 24V AC 4 pole

TIDSBLOKKER/TIDSMODULER

Forpakning	Varenummer	Beskrivelse
4	CV003506	F5-T-0-INNKOBLING-NC1-0,1-3S 1NO+1NC
4	CV003513	F5-T-2-INNKOBLING-NC1-0,1-30S 1NO+1NC
4	CV003520	F5-T-4-INNKOBLING-NC1-10-180S 1NO+1NC
4	CV003537	F5-D-0-UTKOBLING-NC1-0,1-3S 1NO+1NC
4	CV003544	F5-D-2-UTKOBLING-NC1-0,1-30S 1NO+1NC
4	CV003551	F5-D-4-UTKOBLING-NC1-10-180S 1NO+1NC

HJELPEKONTAKTER/HJÄLPKONTAKTER

Forpakning	Varenummer	Beskrivelse
4	CV003568	HJELPEKONTAKTBLOKK-NC1-2NO F4-20
4	CV003575	HJELPEKONTAKTBLOKK-NC1-1NO+1NC F4-11
4	CV003582	HJELPEKONTAKTBLOKK-NC1-2NC F4-02
4	CV003599	HJELPEKONTAKTBLOKK-NC1-4NO F4-40
4	CV003605	HJELPEKONTAKTBLOKK-NC1-3NO+1NC F4-31
4	CV003612	HJELPEKONTAKTBLOKK-NC1-2NO+2NC F4-22
4	CV003629	HJELPEKONTAKTBLOKK-NC1-1NO+3NC F4-13
4	CV003636	HJELPEKONTAKTBLOKK-NC1-4NC F4-04



Kontaktorer

TERMISKE RELE/ÖVERSTRÖMSRELÄ

Forpakning	Varenummer	Beskrivelse
1	CV008914	NR2-25G-NC1 1.6-2.5A
1	CV008921	NR2-25G-NC1 2.5-4A
1	CV008938	NR2-25G-NC1 4-6A
1	CV008945	NR2-25G-NC1 5.5-8A
1	CV008952	NR2-25G-NC1 7-10A
1	CV008969	NR2-25G-NC1 9-13A
1	CV008976	NR2-25G-NC1 12-18A
1	CV008983	NR2-25G-NC1 17-25A
1	CV008997	NR2-36G-NC1 23-32A
1	CV009003	NR2-36G-NC1 28-36A
1	CV009010	NR2-93G-NC1 23-32A
1	CV009027	NR2-93G-NC1 30-40A
1	CV009034	NR2-93G-NC1 37-50A
1	CV009041	NR2-93G-NC1 48-65A
1	CV009058	NR2-93G-NC1 55-70A
1	CV009065	NR2-93G-NC1 63-80A
1	CV009072	NR2-93G-NC1 80-93A
1	CV009089	NR2-200G-NC2 80-1200A
1	CV009096	NR2-200G-NC2 100-160A
1	CV009102	NR2-200G-NC2 1200-200A
1	CV009119	NR2-630G-NC2 160-6300A
1	CV009126	NR2-630G-NC2 200-315A
1	CV009133	NR2-630G-NC2 6300-400A
1	CV009140	NR2-630G-NC2 315-500A
1	CV009157	NR2-630G-NC2 400-630A



Kontaktorer

(115-630A)

- OPPTIL 1000V
- EN 60947
- LEVERES OGSÅ FERDIG FORIGLET

3-POL

Merkestrøm	Forpakning	Varenummer	Beskrivelse
115 A	1	CV003643	NC2-115 N/3P 220V 50/60Hz
150 A	1	CV003650	NC2-150 N/3P 220V 50/60Hz
185 A	1	CV003667	NC2-185 N/3P 220V 50/60Hz
225 A	1	CV003674	NC2-225 N/3P 220V 50/60Hz
265 A	1	CV003681	NC2-265 N/3P 220V 50/60Hz
330 A	1	CV003698	NC2-330 N/3P 220V 50/60Hz
400 A	1	CV003704	NC2-400 N/3P 220V 50/60Hz
500 A	1	CV003711	NC2-500 N/3P 220V 50/60Hz
630 A	1	CV003728	NC2-630 N/3P 220V 50/60Hz

4-POL

Merkestrøm	Forpakning	Varenummer	Beskrivelse
115 A	1	CV003735	NC2-115 N/4P 220V 50/60Hz
150 A	1	CV003742	NC2-150 N/4P 220V 50/60Hz
185 A	1	CV003759	NC2-185 N/4P 220V 50/60Hz
225 A	1	CV003766	NC2-225 N/4P 220V 50/60Hz
265 A	1	CV003773	NC2-265 N/4P 220V 50/60Hz
330 A	1	CV003780	NC2-330 N/4P 220V 50/60Hz
400 A	1	CV003797	NC2-400 N/4P 220V 50/60Hz
500 A	1	CV003803	NC2-500 N/4P 220V 50/60Hz
630 A	1	CV003810	NC2-630 N/4P 220V 50/60Hz





Motorvern- brytere/ Motorskydds- brytare

- EN 60947
- OPPTIL 690 V
- ICU = 100 KA 0-9A
- ICU = 15 KA 9-25A
- ICU = 100 KA FOR SERIE 80B

Merkestrøm	Forpakning	Varenummer	Beskrivelse
0,16	1	CV004541	NS8-25-0,1-0,16
0,25	1	CV004558	NS8-25-0,16-0,25
0,4	1	CV004565	NS8-25-0,25-0,4
0,63	1	CV004572	NS8-25-0,4-0,63
1,0	1	CV004589	NS8-25-0,63-1
1,6	1	CV004596	NS8-25-1-1,6
2,5	1	CV004602	NS8-25-1,6-2,5
4,0	1	CV004619	NS8-25-2,5-4
6,3	1	CV004626	NS8-25-4-6,3
10	1	CV004633	NS8-25-6,3-10
14	1	CV004640	NS8-25-9-14
18	1	CV004657	NS8-25-13-18
23	1	CV004664	NS8-25-17-23
25	1	CV004671	NS8-25-20-25
25	1	CV004688	NS8-80B-16-25
40	1	CV004695	NS8-80B-25-40
63	1	CV004701	NS8-80B-40-63
80	1	CV004718	NS8-80B-56-80



Tilbehør motorvern- brytere/Tilbehør motor- skydds- brytare

Forpakning	Varenummer	Beskrivelse
2	CV004725	UNDERSPENNINGSLØSER NS8-UV (110-115)
2	CV004732	UNDERSPENNINGSLØSER NS8-UV (127)
2	CV004749	UNDERSPENNINGSLØSER NS8-UV (220-240)
2	CV004756	UNDERSPENNINGSLØSER NS8-UV (380-400)
2	CV004763	UNDERSPENNINGSLØSER NS8-UV (380/50 - 440/60)
2	CV004770	SHUNTRIP NS8-SH (110-115)
2	CV004787	SHUNTRIP NS8-SH (127)
2	CV004794	SHUNTRIP NS8-SH (220-240)
2	CV004800	SHUNTRIP NS8-SH (380-400)
2	CV004817	SHUNTRIP NS8-SH (380/50-440/60)
4	CV004824	HJELPEKONTAKT NS8-AE 2,5 2NO
4	CV004831	HJELPEKONTAKT NS8-AE 2,5 1NC/1NO
4	CV004848	HJELPEKONTAKT NS8-AU 6,0 2NO
4	CV004855	HJELPEKONTAKT NS8-AU 6,0 1NC/1NO
4	CV004862	HJELPE/FEIL KONTAKT NS8-FA 1NC - 1NO
4	CV004879	HJELPE/FEIL KONTAKT NS8-FA 1NC - 1NC
4	CV004886	HJELPE/FEIL KONTAKT NS8-FA 1NO - 1NO
4	CV004893	HJELPE/FEIL KONTAKT NS8-FA 1NO - 1NC



Sikringlastskillebryter/ Säkringslastfrånskiljare

- 690V 630A
- IEC 60947-3
- UGNSLUCKA

Type	Forpakning	Varenummer	Beskrivelse
00	1	CV016506	NHR 17-00
1	1	CV016537	NHR 17-1
2	1	CV016544	NHR 17-2
3	1	CV016551	NHR 17-3

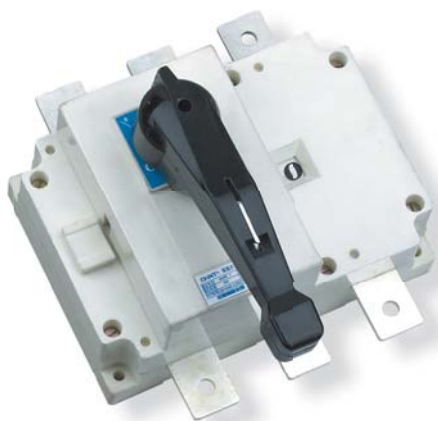

Sikringlastskillebryter/ Säkringslastfrånskiljare

3-POL

Merkestrøm	Forpakning	Varenummer	Beskrivelse
125A	1	CV016568	NH 40-125-3P
160A	1	CV016575	NH 40-160-3P
200A	1	CV016582	NH 40-200-3P
250A	1	CV016599	NH 40-250-3P
315A	1	CV016605	NH 40-315-3P
400A	1	CV016612	NH 40-400-3P
630A	1	CV016629	NH 40-630-3P
1000A	1	CV016636	NH 40-1000-3P
1250A	1	CV016643	NH 40-1250-3P
1600A	1	CV016650	NH 40-1600-3P



4-POL

Merkestrøm	Forpakning	Varenummer	Beskrivelse
125A	1	CV016780	NH 40-125-4P
160A	1	CV016797	NH 40-160-4P
200A	1	CV016803	NH 40-200-4P
250A	1	CV016810	NH 40-250-4P
315A	1	CV016827	NH 40-315-4P
400A	1	CV016834	NH 40-400-4P
630A	1	CV016841	NH 40-630-4P
1000A	1	CV016858	NH 40-1000-4P
1250A	1	CV016865	NH 40-1250-4P
1600A	1	CV016872	NH 40-1600-4P





Sikringslastbrytere/ Säkringslastbrytare

- 690V
- 63-630A
- IEC 60947-3

3-POL

Merkeström	Forpakning	Varenummer	Beskrivelse
63 A	1	CV016667	HH 15-63/3P-2
125A	1	CV016681	HH 15-125/3P-2
160A	1	CV016704	HH 15-160/3P-2
250A	1	CV016728	HH 15-250/3P-2
400A	1	CV016742	HH 15-400/3P-2
630A	1	CV016766	HH 15-630/3P-2

4-POL

Merkeström	Forpakning	Varenummer	Beskrivelse
63 A	1	CV016674	HH 15-63/4P-2
125A	1	CV016698	HH 15-125/4P-2
160A	1	CV016711	HH 15-160/4P-2
250A	1	CV016735	HH 15-250/4P-2
400A	1	CV016759	HH 15-400/4P-2
630A	1	CV016773	HH 15-630/4P-2







Skap og tilbehør/ Centraler och tillbehör

SKAP MED MÅLERFELT/CENTRALER MED MÄTARPLATS

Forpakning	Varenummer	Beskrivelse
1	CV004008	CENIKA-SKAP MRE 480 MÅLERFELT
1	CV009928	CENIKA-SKAP 3 RADER MRE 480 MED MÅLERFELT
1	CV005227	FLEXISKAPET 3X24 MOD + 2X10 MÅLERFELT
1	CV009201	BOLIGSENTRAL 2/21 3/4 MODUL MED SVAKSTRØMFELT
1	CV009911	BOLIGSENTRAL 3/21 3/4 MODUL MED SVAKSTRØMFELT
1	CV009669	3 RADER SIKRINGSRAMME FOR BOLIGSENTRAL FR-1230

REHABILITERINGSMODULER/REHAB MODULER

Forpakning	Varenummer	Beskrivelse
1	CV004015	DE 200 INNSATS FOR D OG E SKAP
1	CV004022	BE 200 INNSATS FOR B OG C SKAP
1	CV008150	RENOVERINGSGRAMME RR D/E 3 RADER
1	CV008204	RENOVERINGSGRAMME RR C/D/E 2 RADER
1	CV009270	RENOVERINGSGRAMME RR F 2 RADER
1	CV009676	RENOVERINGSGRAMME VERNMODUL OV VERN

SKAP UTEN MÅLERPLASS/ CENTRALER UTAN MÄTAR PLATS

Forpakning	Varenummer	Beskrivelse
4	CV009195	MS2 AUTOMATSKAP 2 RAD/36MOD
1	CV009263	MS3 AUTOMATSKAP 3 RAD/54MOD
1	CV009546	FLEXISKAPET 5 X 24 MODULER UTEN MÅLER
1	CV005487	PÅVEGGSKAP 4 MODULER PLAST KV 04 K
1	CV005517	PÅVEGGSKAP 2X14 MODULER IP65 APV28
1	CV005524	PÅVEGGSKAP 3X14 MODULER IP65 APV42
10	CV005449	AVDEKKNING DIN ADS12W
1	CV005401	INNFELT SKAP 24 MOD MED STÅLDØR UPV ST
1	CV005418	INNFELT SKAP 36 MOD MED STÅLDØR UPV ST
1	CV005425	INNFELT SKAP 24 MOD MED POLYMEREDØR UPV KW
1	CV005432	INNFELT SKAP 36 MOD MED POLYMEREDØR UPV KW
1	CV005463	PÅVEGGSKAP 24 MODULER STÅL APV ST
1	CV005470	PÅVEGGSKAP 36 MODULER STÅL APV ST
1	CV005487	PÅVEGGSKAP 4 MODULER PLAST KV 04 K
1	CV005456	FLENS FOR UPV/APV UPV LE

TILBEHØR/TILLBEHÖR

Forpakning	Varenummer	Beskrivelse
1	CV004138	KURSFORTEGNELSE
1	CV005203	MÅLERSLØYFE 3 POL
1	CV005210	MÅLERSLØYFE 4 POL
1	CV005494	AL/CU KLEMME 16-50mm2
1	CV008181	RINGETRAFO 8V
10	CV010115	JORDSKINNE 12 PE GRØNN/GUL
10	CV010122	JORDSKINNE 12 PE GRØNN/GUL
10	CV010139	JORDSKINNE 15 PE GRØNN/GUL
10	CV010146	SCHUKOSTIKK DINMONTERT ENKEL



Målere/Mätare

- EN 62053-21
- PULS UTGANG
- TYPE 1

Merkestrøm	Forpakning	Varenummer	Beskrivelse
32	18	CV007986	ADM1TE 32A 1 MODUL 1+N
90	1	CV007993	DRM75A DIREKTE MEKANISK 1+N
90	1	CV008006	DRM75D DIREKTE DIGITAL 1+N
90	1	CV008013	DRM1250A MEKANISK 3+N
90	1	CV008020	DRM1250D DIGITAL 3+N
16	1	CV008037	PM16AR PLUGGMÅLER MED SCHUKO
16	1	CV008044	PM150 PLUGGMÅLER MED MAKSVOKTER
Trafo	1	CV008051	DRM75A CT MEKANISK TRAFØ 1+N 5A
Trafo	1	CV008068	DRM1250A CT MEKANISK TRAFØ 3+N 5A
90	1	CV008099	DRM75A 2 POL 230V MEKANISK IT 230V 2 FASE
90	1	CV008105	DRM1250A 3 POL 230V MEKANISK IT 230V 3 FASE
Trafo	1	CV008112	DRM75A 2 POL 230V CT MEKANISK IT 230V TRAFØ
Trafo	1	CV008129	DRM1250A 3 POL 230V CT MEKANISK IT 230V TRAFØ

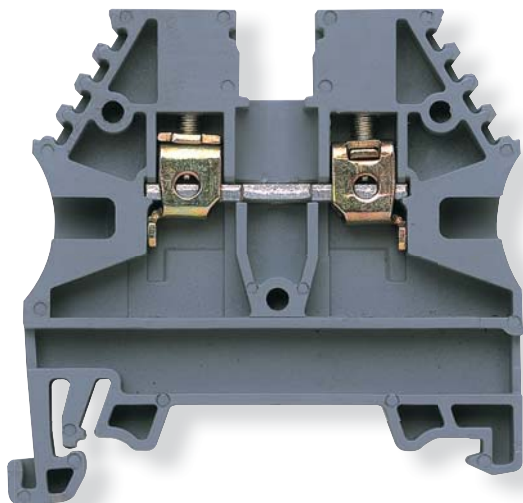

Rekkeklemme/ Radklämmor skruv

VI LAGERFØRER OG FJÆRKLEMMER/LAGERFØR ÆVEN FJÆDERKLÄMMOR

- EN 60947
- DNV OG ATEX GODKJENT

Forpakning	Varenummer	Beskrivelse
100	CK304120	AVK 2,5 REKKEKLEMME/RADPLINT SKRUV GRÅ
100	CK304130	AVK 4 REKKEKLEMME/RADPLINT SKRUV GRÅ
100	CK304140	AVK 6 REKKEKLEMME/RADPLINT SKRUV GRÅ
100	CK304150	AVK 10 REKKEKLEMME/RADPLINT SKRUV GRÅ
50	CK304160	AVK 16 REKKEKLEMME/RADPLINT SKRUV GRÅ
50	CK304170	AVK 35 REKKEKLEMME/RADPLINT SKRUV GRÅ
10	CK304190	AVK 70 REKKEKLEMME/RADPLINT SKRUV GRÅ
5	CK304300	AVK 95B REKKEKLEMME/RADPLINT SKRUV GRÅ
5	CK304310	AVK 150B REKKEKLEMME/RADPLINT SKRUV GRÅ
5	CK304320	AVK 240B REKKEKLEMME/RADPLINT SKRUV GRÅ
100	CK304121	AVK 2,5 REKKEKLEMME/RADPLINT SKRUV BLÅ
100	CK304131	AVK 4 REKKEKLEMME/RADPLINT SKRUV BLÅ
100	CK304141	AVK 6 REKKEKLEMME/RADPLINT SKRUV BLÅ
100	CK304151	AVK 10 REKKEKLEMME/RADPLINT SKRUV BLÅ
50	CK304161	AVK 16 REKKEKLEMME/RADPLINT SKRUV BLÅ
50	CK304171	AVK 35 REKKEKLEMME/RADPLINT SKRUV BLÅ
50	CK304191	AVK 70 REKKEKLEMME/RADPLINT SKRUV BLÅ



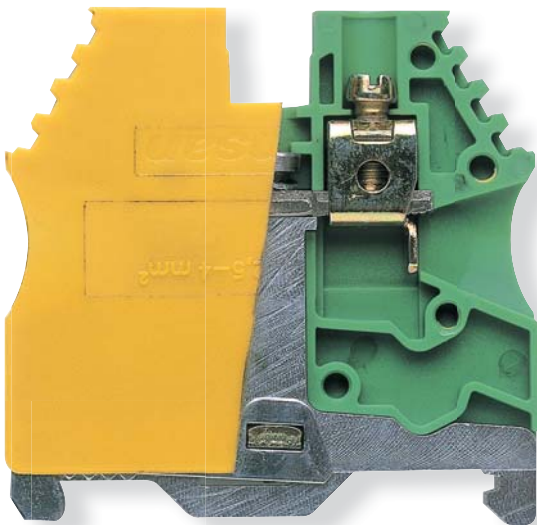
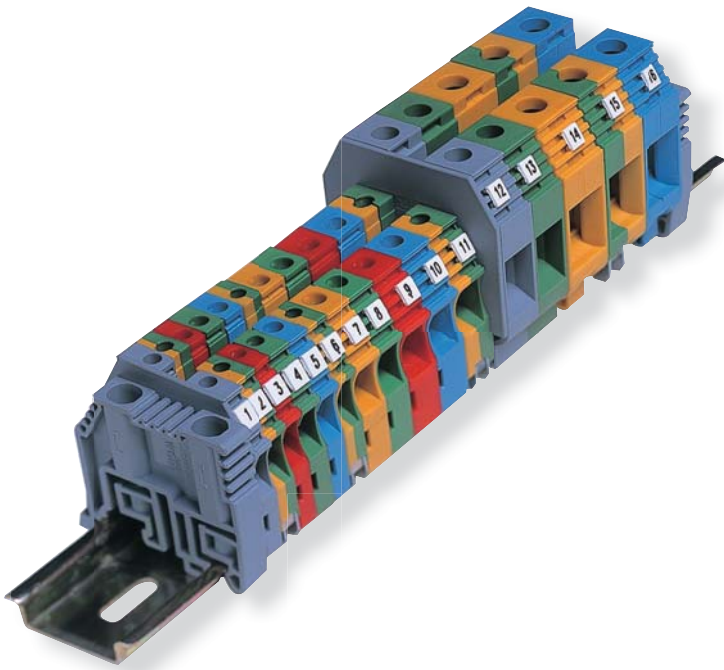

ETASJEKLEMMER/VÅNINGSPLOINT

Forpakning	Varenummer	Beskrivelse
100	CK317109	PIK 2,5N ETASJEKLEMME/VÅNINGSPLOINT GRÅ
100	CK319109	PIK 4N ETASJEKLEMME/VÅNINGSPLOINT GRÅ
100	CK324109	PUK 3 ETASJEKLEMME/VÅNINGSPLOINT GRÅ
100	CK324209	PUK 2T ETASJEKLEMME/VÅNINGSPLOINT M JORD GRÅ
100	CK324309	PUK 3T ETASJEKLEMME/VÅNINGSPLOINT MED JORD GRÅ

JORDKLEMMER/JORDPLOINT

Forpakning	Varenummer	Beskrivelse
50	CK334120	AVK 2,5/4T JORDKLEMME/JORDPLOINT
25	CK334140	AVK 6/10T JORDKLEMME/JORDPLOINT
25	CK334160	AVK 16/35T JORDKLEMME/JORDPLOINT

KNIVSKILLE / SIKRINGSKLEMME FRÅNSKILJBARA/SÅKRINGSPLOINT

Forpakning	Varenummer	Beskrivelse
100	CK351109	ASK 2S SIKRINGSKLEMME/SÅKRINGSPLOINT
100	CK353109	ASK 3 A KNIVSKILLEKLEMME/FRÅNSKILJBAR PLOINT

ENDEPLATE/ÄNDPLATTOR

Forpakning	Varenummer	Beskrivelse
25	CK444120	NPP / AVK 2,5-10 ENDEPLATE
25	CK444160	NPP / AVK 16 ENDEPLATE
25	CK449019	NPP / PIK 2,5-4N ENDEPLATE
25	CK450049	NPP / ASK 2 ENDEPLATE
25	CK450059	NPP / ASK 3 ENDEPLATE
25	CK450139	NPP / PUK 3 ENDEPLATE
25	CK450149	NPP2T / PUK 2T ENDEPLATE
25	CK450159	NPP / PUK 3T ENDEPLATE

ENDESTOPPERE/ÄNDSTÖD

Forpakning	Varenummer	Beskrivelse
100	CK495039	WGD1 ENDESTOPPER/ÄNDSTÖD
100	CK495049	KD 3 ENDESTOPPER/ÄNDSTÖD
100	CK495050	KD 4 ENDESTOPPER/ÄNDSTÖD

LASKER/ÖVERKOPPLINGAR

Forpakning	Varenummer	Beskrivelse
25	CK474122	UK 2,5/2 - AVK LASK/ÖVERKOPPLING
20	CK474123	UK 2,5/3 - AVK LASK/ÖVERKOPPLING
15	CK474124	UK 2,5/4 - AVK LASK/ÖVERKOPPLING
5	CK474129	UK 2,5/10 - AVK LASK/ÖVERKOPPLING
25	CK474132	UK 4/2 - AVK LASK/ÖVERKOPPLING
20	CK474133	UK 4/3 - AVK LASK/ÖVERKOPPLING
15	CK474134	UK 4/4 - AVK LASK/ÖVERKOPPLING
5	CK474139	UK 4/10 - AVK LASK/ÖVERKOPPLING
25	CK474142	UK 6/2 - AVK LASK/ÖVERKOPPLING
20	CK474143	UK 6/3 - AVK LASK/ÖVERKOPPLING
15	CK474144	UK 6/4 - AVK LASK/ÖVERKOPPLING
5	CK474149	UK 6/10 - AVK LASK/ÖVERKOPPLING
25	CK474152	UK 10/2 - AVK LASK/ÖVERKOPPLING
20	CK474153	UK 10/3 - AVK LASK/ÖVERKOPPLING
15	CK474154	UK 10/4 - AVK LASK/ÖVERKOPPLING
5	CK474159	UK 10/10 - AVK LASK/ÖVERKOPPLING
25	CK474162	UK 16/2 - AVK LASK/ÖVERKOPPLING
20	CK474163	UK 16/3 - AVK LASK/ÖVERKOPPLING
15	CK474164	UK 16/4 - AVK LASK/ÖVERKOPPLING
5	CK474169	UK 16/10 - AVK LASK/ÖVERKOPPLING
25	CK474172	UK 35/2 - AVK LASK/ÖVERKOPPLING
20	CK474173	UK 35/3 - AVK LASK/ÖVERKOPPLING
15	CK474174	UK 35/4 - AVK LASK/ÖVERKOPPLING
5	CK474179	UK 35/10 - AVK LASK/ÖVERKOPPLING



MERKING/MÄRKNING DEKAFIX

Forpakning	Varenummer	Beskrivelse
500	CK496119	GE MODULÆR GRUPPEMERKING
501	CK498130	IP 2S MERKE MED SYMBOL
502	CK498140	IP 2 MERKE BLANK
503	CK505000	DY 5 "0"
504	CK505001	DY 5 "1"
505	CK505002	DY 5 "2"
506	CK505003	DY 5 "3"
507	CK505004	DY 5 "4"
508	CK505005	DY 5 "5"
509	CK505006	DY 5 "6"
510	CK505007	DY 5 "7"
511	CK505008	DY 5 "8"
512	CK505009	DY 5 "9"
513	CK505010	DY 5 "10"
514	CK505020	DY 5 "1-10"
515	CK505021	DY 5 "11-20"
516	CK505022	DY 5 "21-30"
517	CK505023	DY 5 "31-40"
518	CK505024	DY 5 "41-50"
519	CK505030	DY 5 "10-100"
520	CK505040	DY 5 "1-50"
521	CK505041	DY 5 "51-100"
522	CK505042	DY 5 "101-150"
523	CK505043	DY 5 "151-200"
524	CK505044	DY 5 "201-250"
525	CK505045	DY 5 "251-300"
526	CK505046	DY 5 "301-350"
527	CK505047	DY 5 "351-400"
528	CK505048	DY 5 "401-450"
529	CK505049	DY 5 "451-500"
530	CK505050	DY 5 "501-550"
531	CK505051	DY 5 "551-600"
532	CK505052	DY 5 "601-650"
533	CK505053	DY 5 "651-700"
534	CK505054	DY 5 "701-750"
535	CK505055	DY 5 "751-800"
536	CK505056	DY 5 "801-850"
537	CK505057	DY 5 "851-900"
538	CK505058	DY 5 "901-950"
539	CK505059	DY 5 "951-999"
540	CK505060	DY 5 "A"
541	CK505061	DY 5 "B"
542	CK505062	DY 5 "C"
543	CK505063	DY 5 "D"
544	CK505064	DY 5 "E"
545	CK505065	DY 5 "F"
546	CK505066	DY 5 "G"
547	CK505067	DY 5 "H"
548	CK505068	DY 5 "I"
549	CK505069	DY 5 "J"
550	CK505070	DY 5 "K"
551	CK505071	DY 5 "L"
552	CK505072	DY 5 "M"
553	CK505073	DY 5 "N"
554	CK505074	DY 5 "O"
555	CK505075	DY 5 "P"
556	CK505076	DY 5 "Q"
557	CK505077	DY 5 "R"
558	CK505078	DY 5 "S"
559	CK505079	DY 5 "T"
560	CK505080	DY 5 "U"
561	CK505081	DY 5 "V"
562	CK505082	DY 5 "W"
563	CK505083	DY 5 "X"
564	CK505084	DY 5 "Y"
565	CK505085	DY 5 "Z"
566	CK505090	DY 5 "L1"
567	CK505091	DY 5 "L2"
568	CK505092	DY 5 "L3"
569	CK505093	DY 5 "RSTNJ"
570	CK505094	DY 5 "MP"
571	CK505095	DY 5 "+"
572	CK505096	DY 5 "-"
573	CK505097	DY 5 "JORD"





Endehylser/Ändhylsor

ISOLERTE/ISOLERADE

Forpakning	Varenummer	Beskrivelse
500	CK570010	ISOLERT ENDEHYLSE IKY 0,50/8 ORANGE
500	CK570020	ISOLERT ENDEHYLSE IKY 0,75/8 HVIT
500	CK570030	ISOLERT ENDEHYLSE IKY 1,0/8 GUL
500	CK570040	ISOLERT ENDEHYLSE IKY 1,5/8 RØD
250	CK570050	ISOLERT ENDEHYLSE IKY 2,5/8 BLÅ
250	CK570060	ISOLERT ENDEHYLSE IKY 4,0/9 GRÅ
100	CK570070	ISOLERT ENDEHYLSE IKY 6,0/12 SORT
100	CK570080	ISOLERT ENDEHYLSE IKY 10/12 ELFENBEN
50	CK570090	ISOLERT ENDEHYLSE IKY 16/12 GRØNN
20	CK570100	ISOLERT ENDEHYLSE IKY 25/16 BRUN
20	CK570110	ISOLERT ENDEHYLSE IKY 35/25 BEIGE
20	CK570120	ISOLERT ENDEHYLSE IKY 50/20 OLIVEN

UISOLERTE/OISOLERADE

Forpakning	Varenummer	Beskrivelse
500	CK571010	UISOLERT ENDEHYLSE KY 0,50/10 ORANGE
500	CK571020	UISOLERT ENDEHYLSE KY 0,75/10 HVIT
500	CK571030	UISOLERT ENDEHYLSE KY 1,0/10 GUL
500	CK571040	UISOLERT ENDEHYLSE KY 1,5/10 RØD
250	CK571050	UISOLERT ENDEHYLSE KY 2,5/12 BLÅ
250	CK571060	UISOLERT ENDEHYLSE KY 4/12 GRÅ
100	CK571070	UISOLERT ENDEHYLSE KY 6/12 SORT
100	CK571080	UISOLERT ENDEHYLSE KY 10/12 ELFENBEN
50	CK571090	UISOLERT ENDEHYLSE KY 16/12 GRØNN

ISOLERTE DOBLE/ISOLERADE DUBBEL

Forpakning	Varenummer	Beskrivelse
500	CK572010	ISOLERT DOBBEL ENDEHYLSE IKY 2x0,50/8 ORANGE
500	CK572020	ISOLERT DOBBEL ENDEHYLSE IKY 2x0,75/8 HVIT
500	CK572030	ISOLERT DOBBEL ENDEHYLSE IKY 2x1,0/8 GUL
250	CK572040	ISOLERT DOBBEL ENDEHYLSE IKY 2x1,5/8 RØD
200	CK572050	ISOLERT DOBBEL ENDEHYLSE IKY 2x2,5/10 BLÅ
100	CK572060	ISOLERT DOBBEL ENDEHYLSE IKY 2x4/12 GRÅ
75	CK572070	ISOLERT DOBBEL ENDEHYLSE IKY 2x6/14 SORT
50	CK572080	ISOLERT DOBBEL ENDEHYLSE IKY 2x10/14 ELFENBEN
20	CK572090	ISOLERT DOBBEL ENDEHYLSE IKY 2x16/14 GRØNN

Reläer Plugg-in

NEDAN VISSAS ETT URVAL AV SPÄNNINGAR
ANDRA SPÄNNINGAR OCH TYPER LAGERFÖRS.
KONTAKTA OSS FÖR MERA TEKNISKA DETALJER

SERIE RFS MINI 1-2 POLIGA (5 RESP 8 PINS) INTERFACE

Forpakning	Varenummer	Beskrivelse
10	RQ002025	Relä 1pol,10 A-024AC,Led
10	RQ002026	Relä 1pol,10 A-024DC,Led
10	RQ002034	Relä 1pol,10 A-220/230AC,Led
10	RQ002041	Relä 1pol,10 A-024AC
10	RQ002042	Relä 1pol,10 A-024DC
10	RQ002050	Relä 1pol,10 A-220/230AC
10	RQ002057	Relä 2pol,5 A-024AC,Led
10	RQ002058	Relä 2pol,5 A-024DC,Led
10	RQ002066	Relä 2pol,5 A-220/230AC,Led
10	RQ002073	Relä 2pol,5 A-024AC
10	RQ002074	Relä 2pol,5 A-024DC
10	RQ002082	Relä 2pol,5 A-220/230AC
10	RQ002394	Socket 1-pol för relä RF1 skruv
10	RQ002396	Socket 2-pol för relä RF2 skruv
10	RQ002398	Socket 1-pol Quick-Clamp för relä RF1
10	RQ002399	Socket 2-pol Quick-Clamp för relä RF2

SERIE RQS MINIATYR 2-4 POLIGA (8 RESP 14 PINS)

Forpakning	Varenummer	Beskrivelse
10	RQ002307	Relä 2pol,10 A-024AC,Led & Test.
10	RQ002309	Relä 2pol,10 A-024DC,Led & Test.
10	RQ002325	Relä 2pol,10 A-220/230AC,Led.
10	RQ002332	Relä 2pol,10 A-024AC.
10	RQ002333	Relä 2pol,10 A-024DC.
10	RQ002343	Relä 2pol,10 A-220/230AC.
10	RQ002355	Relä 4pol,5 A-024AC,Led & Test.
10	RQ002357	Relä 4pol,5 A-024DC,Led & Test.
10	RQ002373	Relä 4pol,5 A-220/230AC,Led & Test.
10	RQ002380	Relä 4pol,5 A-024AC.
10	RQ002381	Relä 4pol,5 A-024DC.
10	RQ002391	Relä 4pol,5 A-220/230AC.
10	RQ002404	Socket 2-pol för relä RQ2, modul
10	RQ002405	Socket 2-pol för relä RQ2
10	RQ002407	Socket 4-pol för relä RQ4, modul, skruv
10	RQ002408	Socket 4-pol för relä RQ4, skruv
10	RQ002412	Socket 2-pol Quick-Clamp relä RQ2, modul
10	RQ002413	Socket 2-pol Quick-Clamp relä RQ2
10	RQ002414	Socket 4-pol Quick-Clamp för relä RQ4, modul
10	RQ002415	Socket 4-pol Quick-Clamp för relä RQ4

SERIE RMS INDUSTRIRELÄER 11-PINS

Forpakning	Varenummer	Beskrivelse
10	RQ002120	Relä 3pol,10 A-024AC,Test & Led
10	RQ002122	Relä 3pol,10 A-024DC,Test & Led
10	RQ002143	Relä 3pol,10 A-220/230AC,Test & Led
10	RQ002157	Relä 3pol,10 A-024AC,Test
10	RQ002159	Relä 3pol,10 A-024DC,Test
10	RQ002180	Relä 3pol,10 A-220/230AC,Test
10	RQ002400	Socket standard för 11-pins lång
10	RQ002401	Socket standard för 11-pins kort

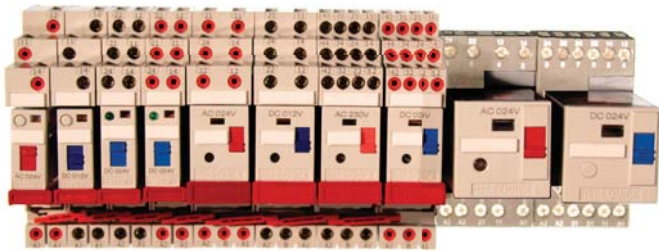

Cenika AS lanserer en ny serie jordfeil- automater

- Enkelt å ta ut midt i en rekke
- To solide fester sikrer mot vridning på DIN skinne
- Festene kan låses i åpen posisjon noe som forenkler monteringen



NÅR STØRRELSEN TELLER

*Verdens minste
kwh-måler*

DIN-MONTERT:

17,5 x 90 x 58,5 mm

ADM1 TE - 1-fase



REFERANSEANLEGG

- Rygge flyplass
- Post og Teletilsynet, Lillesand
- Netthandelen, Kristiansand
- Fjordspeilet, Leiligheter Stavanger
- Arena senter, Arendal
- Riska Ungdomskole
- Sørlandschips, ny linje
- Galåsmyra borettslag, Bodø
- Volstadberga borettslag, Ålesund
- Øya Landbruksskole, Kvål
- Kjøpesentert Lade i Trondheim
- Byggmakker, Steinkjær
- Kiwi, Steinkjær
- Jækteby'n 3, borettslag, Steinkjær
- Østrehavn, borettslag, Namsos
- Risenga Svømmehall
- Nye Grønlandskvartalet
- Salhus Museumssenter
- Lunder skole
- Norges Musikkhøyskole
- Nye kompetansesenter Tromsø
- Kveldsrud konferansesenter
- Universitetet i Oslo
- Sogndal Flyplass
- Moer Sykehjem
- Sentrallager Askø Bergen (36 000 kvm, kjøleanlegg + dist. Anlegg)
- Camilla collets Gate Eldrehjem
- Blystadringen (184 leiligheter, rehab. Innsatser)
- Minken Borettslag (154 leiligheter)
- Nebbestølen Borettslag (152 leiligheter)
- Tjernet Borettslag (216 leiligheter)
- Med fl. Se oppdatert liste på våre nettsider
- Vi har levert over 60 anlegg fra 1600A og større





CENIKA AS FIKK GOD EKSPONERING SOM SPONSOR FOR GRAND SLAM TURNERINGEN I STAVANGER

Cenika AS gikk inn som en av sponsorene på Grand Slam turneringen i Stavanger. Dette ble en utrolig positiv erfaring og Cenika kommer til å være med også i 2008.

Gratis frakt: Vi spanderer frakten hvis ordren overstiger kr. 3000,-

Besøk våre nettsider
www.cenika.no eller
www.cenika.se
 for ytterligere
 informasjon



LANSERINGEN AV CENIKA PÅ ELFAK 07 BLE EN SUKSESS

Vi har fått en god start både i Sverige og Danmark med leveranser til flere av de største tavlebyggerene. Levering skjer fra vår datterbedrift Cenika AB i Malmö.

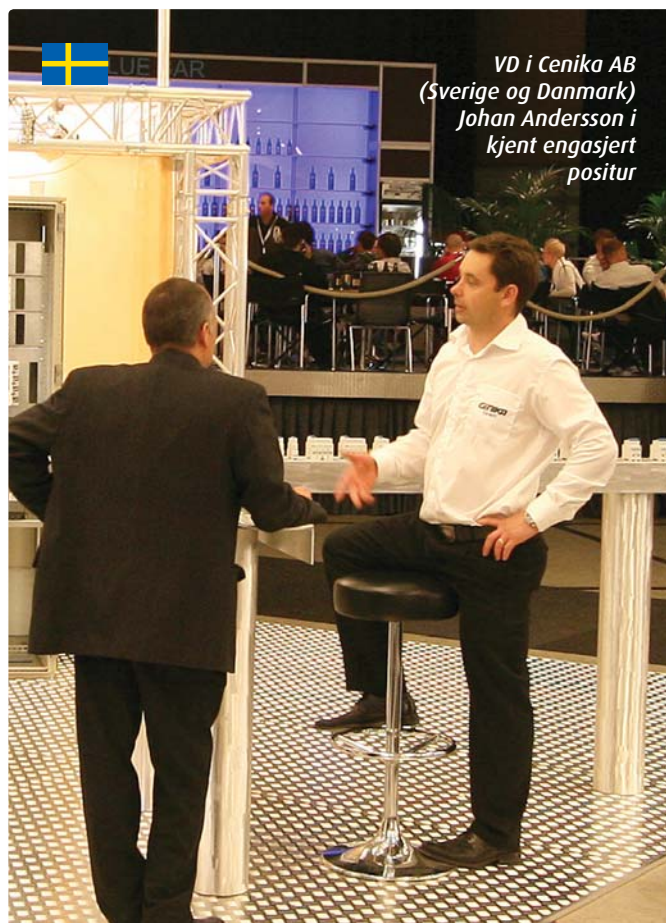

VD i Cenika AB
 (Sverige og Danmark)
 Johan Andersson i
 kjent engasjert
 positur



Cenikas nye lokaler i Vebjørnsvei 5 i Lier



Cenikas nye lokaler i Sverige

Krossverksgatan 11G, SE 216 16 Limhamn, SVERIGE



CENIKA



RoHS og WEEE direktivet

Cenika AS leverer iht RoHS og WEEE direktivet. Dette trådte i kraft fra 1. juli og alle våre leverandører leverer nå iht dette direktivet.



Medlem av:



Cenika AS

Vebjørnsvei 5
3400 LIER
NORGE

Telefon: +47 32 24 03 00

Telefax: +47 32 24 03 01

www.cenika.no



Cenika AB

Krossverksgatan 11G
SE 216 16 Limhamn
SVERIGE

Phone: +46-40-631 55 00

Fax: +46-40-15 67 60

www.cenika.se

Kontaktinfo:

Kontaktpersoner	Direktenr.	Region
Robert Tillerflaten	411 43 051	Nord
Frode Sylte	489 996 00	Vest
Thomas Pedersen	411 43 050	Sør
Svein Tore Moe	402 90 040	Øst
Kai Harald Wang	908 66 497	Buskerud, Vestfold, Telemark
Trond Øines	917 99 979	Akershus, Oslo, Hedemark

Kontaktinfo:

Kontaktpersoner	Direktenr.	Region
Johan Andersson	040-6315501	Sverige/Danmark
Mikael Ekström	040-6315502	Sverige/Danmark

Har du tekniske spørsmål, ta kontakt med **John Knudsen** på tlf 918 82 525 eller send e-mail på jek@cenika.no

Vi hjelper deg med lokal markedsføring

Kontakt oss for nærmere info

