

The toroidal core transformer

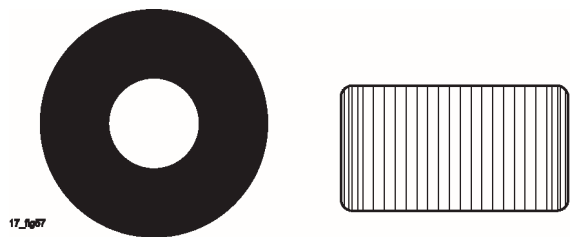

The toroidal core transformer works according to the same principle as the conventional iron core transformer. It is an approximately ideal construction which uses a minimum of materials. The windings are distributed symmetrically through 360°, tight to the core. This produces a transformer which can be up to 50% lighter than the conventional electric transformer. A toroidal core transformer wound through 360° automatically produces a very low leakage reactance (e_x) by virtue of the ideal coupling. The compact format offers great freedom of choice in terms of design. If the iron cross-section is constant, the height and diameter can be changed or adapted to requirements.

The compact construction of an iron core without an air gap and windings distributed symmetrically over the entire core ensures a stable and vibrationfree structure which does not normally give off magnetic radiation or noise (hum). This makes it possible to put other components closer to the transformer and so save space.

The tightly packed iron core of directional Si-iron uses very low magnetisation currents and so has a low no-load loss. But because of the optimum core without air gaps and good coupling, combined with a large amount of iron in relation to copper, the toroidal core has much higher actuating currents than conventional transformers. This must be taken into account when dimensioning line-side fuses.

Toroidal core transformers are used in many areas, including measurement and control, communications, medical instrumentation, audio and studio technology and a wide range of other electrical installations which require low magnetic radiation or a low overall height.

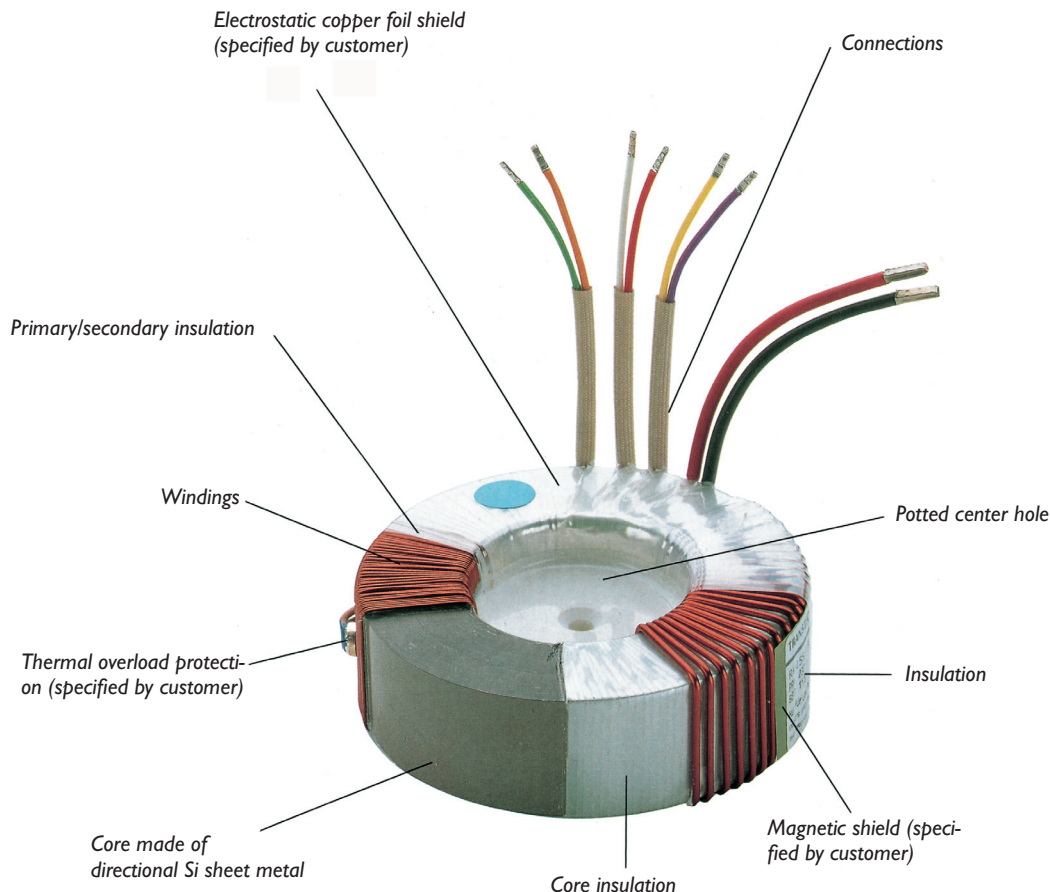

Other core types

In addition to the core types we are concerning ourselves with here, there are a number of other core types: transducers, modular cores, plug-in cores, cores for stabilisers and cores which are special adapted for welding instead of a traditional blend, to name but a few. All cores can be supplied in different qualities of sheet metal, i.e. by increasing the quality it is possible to obtain higher power from the same dimensions. Sheet metal of a higher quality is also more expensive, of course.

El cores

El cores are frequently used in small, conventional transformers with low frequency or reactors of up to 750V and 4 kVA. The transformer is often wound in the form of a two-chamber device to achieve a large enough insulation spacing. This gives a much larger reactance/voltage drop than a single-chamber device.



17_Ap6

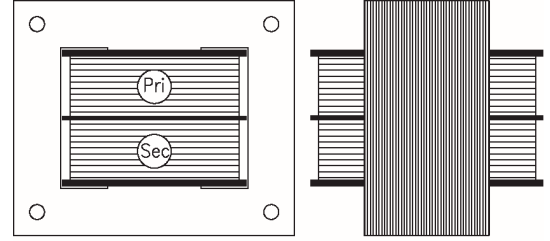

17_fig55

UI cores

UI cores are frequently used in large, single-phase, low-frequency transformers or reactors of up to typical 750 V and 20 kVA. In this case larger reactances can be achieved by having the primary and secondary windings on separate limbs. Having the windings on separate limbs also allows the voltage to be increased to several kilovolts.



17_Ap6

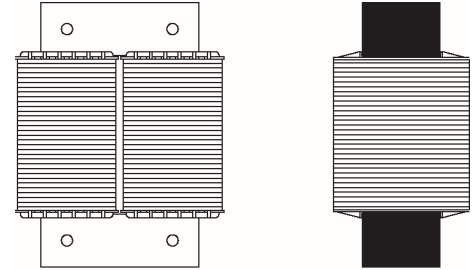

17_Ap6

3UI cores

3UI cores are mainly used in three-phase, low-frequency transformers or reactors of up to typical 35 kVA.

3UI cores are identical to UI cores, but have one limb more. The same insulating material can be used.



17_Ap6

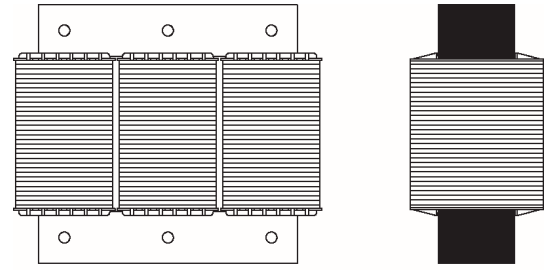

17_Ap6

M cores

The M core is basically very similar to the El core, but has a small air gap on the centre limb which can be exploited in reactors, transformers with high reactances and wideband transformers for aircraft, military equipment, etc.



17_Ap6

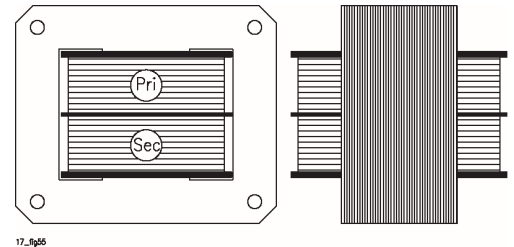

17_fig55

C cores

C cores are frequently used in transformers with high-frequencies, i.e. 100 Hz and above. C cores give a compact construction with the same properties as UI cores. They often use many of the same insulating materials as UI cores.



17_fig56b

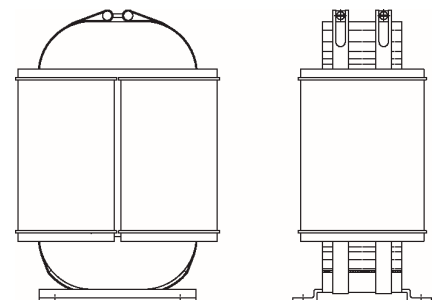

17_fig56