

Advantages

- **Saving of energy and water**
Less transmission loss and limited waste of heat and water through drain. Besides, a better utilization of the capacity of the hot water tank is obtained.
- **Comfort**
Constant temperature. Even at variable consumption.
- **Safety**
The bath water cannot scald.
- **Minimum maintenance**
The Evertemper System is robust and eliminates scale.

The Evertemper System

It consists of a Clorius 3-way valve with thermostat type V and a mixing tank in which water from the hot water tank is – centrally – mixed with cold water and return water from the circulation of the system. Irrespective of the drain-off quantity and the temperature of the hot water tank the bath water always has the desired temperature.

Evertemper can be mounted in two ways:

System A

The 3-way valve distributes cold water
As the valve – in cold water – is less exposed to scale deposits and heat strains, this system is preferred provided that large quantities of hot water are not being drained off directly from the hot water tank for other uses. Balancing valves should be mounted on both outlets of the 3-way valve in order to give equal resistance in both circuits to the mixing tank.

System B

Hot and cold water is mixed in the 3-way valve

This system is used where parallel with warmed water for bathing – hot water is also necessary, e.g. for use in the kitchen. In system B the valve is both exposed to heat strains and scale as it at the same time is exposed to cold and hot water. Balancing valves should be mounted on both inlets to the mixing valve to secure equal resistance in both circuits. For mixing of cold water and return water a lateral Y-piece must be used. Please see drawing.

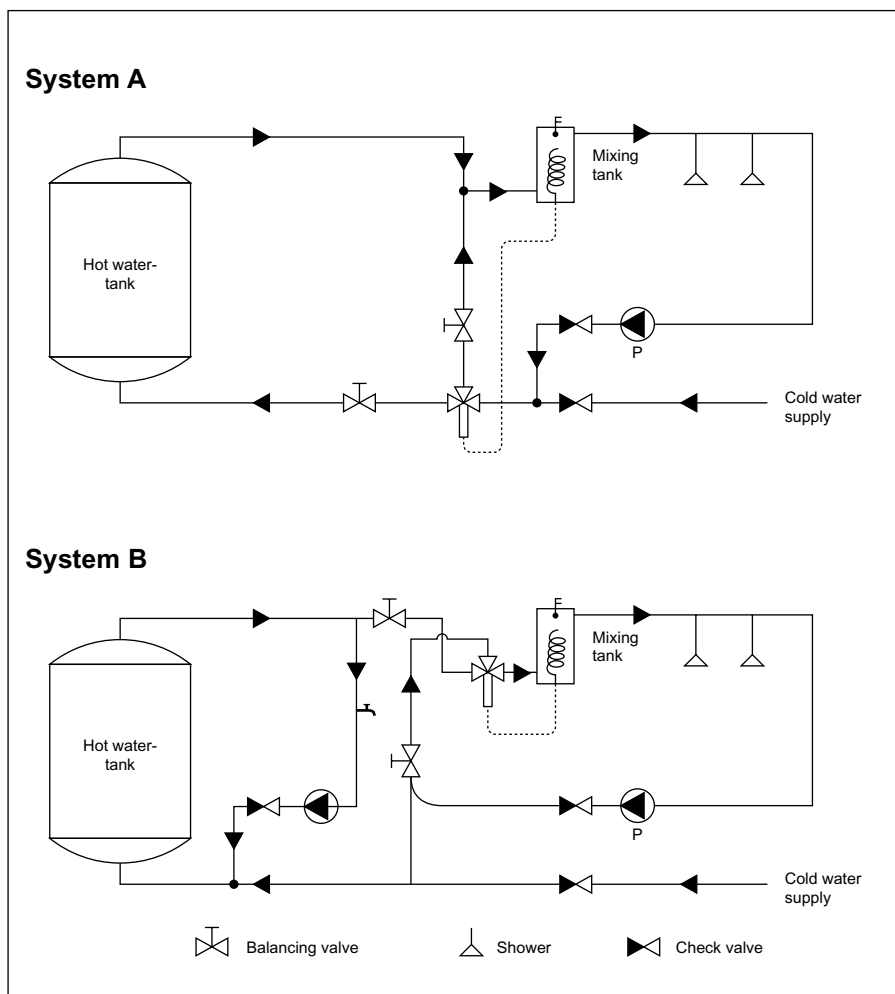

Subject to changes without notice.

Valve 15 - 20 L3S

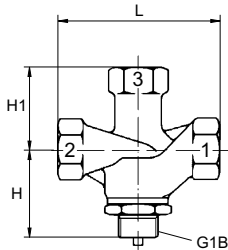

Valve 25 - 50 L3S

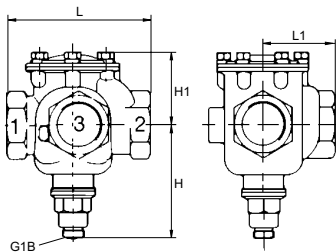

Valve M3F

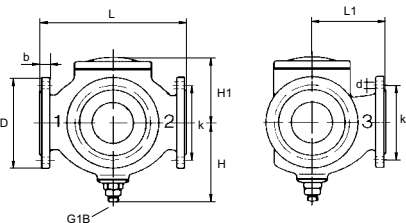

Thermostat V4.05 - V4.10

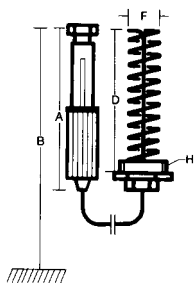

Mixing tank

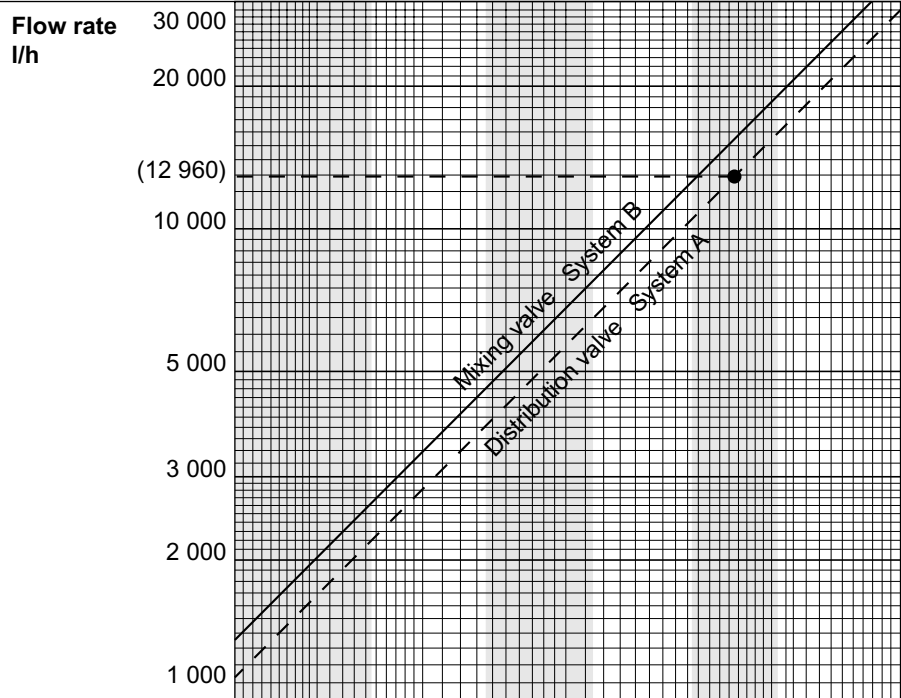
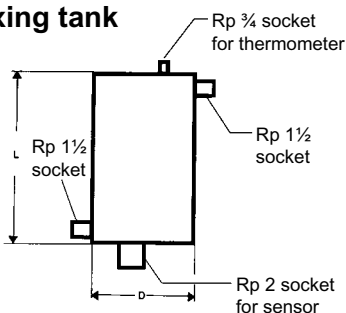

Valve	type	15 L3S	20 L3S	25 L3S/M3F	32 L3S/M3F	40 L3S/M3F	50 L3S/M3F
		L mm	110	110	140	140	185
H mm		60	60	145	145	150	150
H1 mm		55	55	80	80	105	105
Thermostat	type	V4.05			V4.10		
		dim.		V4.05 A: 385 mm V4.10 A: 385 mm	B: 525 mm B: 525 mm	D: 235 mm D: 235 mm	F: 49 mm F: 49 mm
Mixing tank	type	1	1	1	1	1	1
		L mm	430	430	430	430	430
	D mm	154	154	154	154	154	154
	Volume l	8	8	8	8	8	8

Sizing of System

The above diagram can be used to size the components of the Evertemper System. If the desired pressure drop over the 3-way valve differs from 0.5 bar please refer to our datasheet for 3-way valves no. 2.2.07.

For both system A and B, it is very important that valves are correctly dimensioned and also that the circulating pumps (P) are suitable sized to circulate at least 20% of the flow rate for which the plant is dimensioned.

Mixing tank

Should you manufacture the mixing tank yourselves, it is important to keep the dimensions stated above.

Example:

A plant in accordance to system "A" consists of 18 showers with a capacity of 0.2 l/sec, in total 12960 l/h. This flow rate is found on the left side of the above diagram from where a horizontal line is followed until it intersects with the line "Distribution Valve System A". This intersection is within the vertical grey area marked 40 L3S/M3F and below this the other components and their dimensions are shown. The Evertemper System in this example will consist of one 40 mm valve type L3S/M3F, one thermostat type V4.10 and one mixing tank. The minimum flow rate circulated by the pump is 2590 l/h.

Subject to changes without notice.