

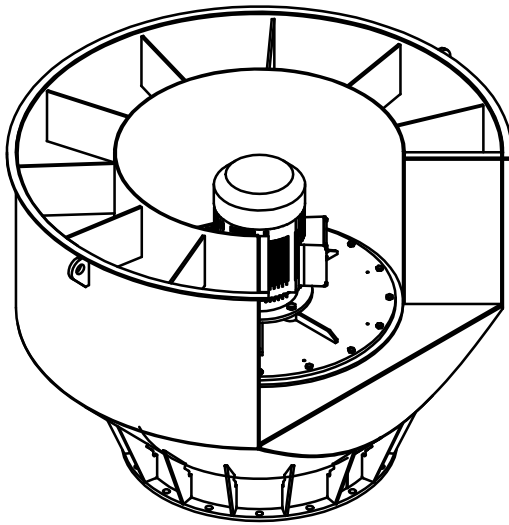

EX PROOF FANS
for Hazardous Area

PUV - D1RX



PPV - D10X

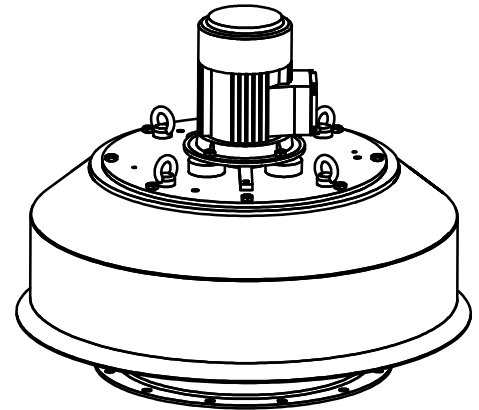

SUV - B1RX

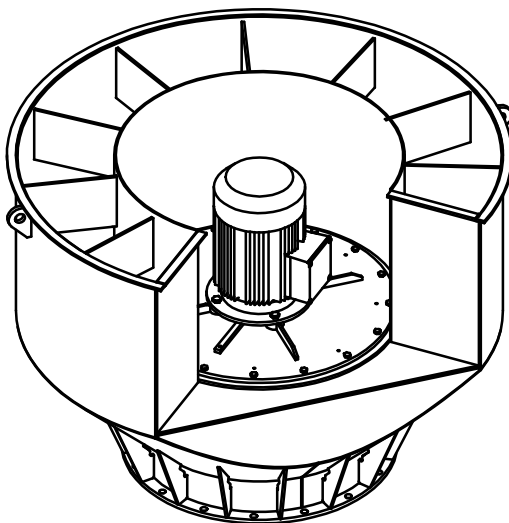

HSV - B1(AFX)

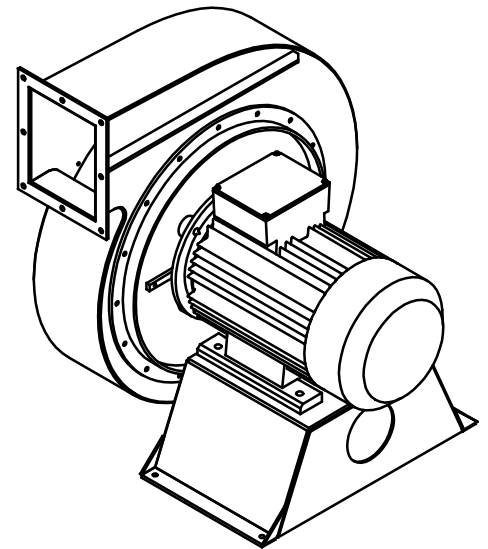

N Y B O R G A S

N-6230 SYKKYLVEN, NORWAY
TEL +47 70 25 40 80 - FAX +47 70 25 29 08
office@nyborgfan.com - www.nyborgfan.com



PROPELLER EXHAUST FAN FOR EXPLOSIVE FUMES

TYPE
PUV-D1RX



APPLICATIONS

Typical application for this fan is mechanical ventilation, extraction, in hazardous zones of cargo area and rooms onboard ships. Duc-top, above deck mounting.

From the Det Norske Veritas system requirements, mechanical ventilation in cargo area:

A 100 General.

109 Electric fan motors are not to be installed in ventilation ducts when the ship has to carry flammable products.

111 Ventilation outlets from gas-dangerous spaces are to discharge upwards in location at least 10m in the horizontal direction from ventilation intakes and openings for gas-safe spaces.

DESIGN

The PUV-D1RX is designed primary for ventilation, extraction, of pump-rooms and other places where explosive fumes occur. The fan is spark proof with a totally enclosed, natural cooled and flameproof electric motor.

Long experience has contributed to a simple construction, with only one rotating part in addition to the motor itself. The propeller is mounted directly to the motor shaft, thus making it one unit with the motor flange, which can be lifted out for inspection.

EXECUTION

The propeller, fan casing, motor flange and guiding plate are made of salt- and ammonia resistant aluminium. The propeller is aerodynamically shaped and balanced with various pitch angles to suit different pressures and capacities. The wire mesh guard is made of stainless steel.

Greasing-point for the gas tight assembly is provided on top of motor flange.

The PUV-D1RX can be delivered in the range **from size no 260 to size no 1100**.

ELECTRIC MOTOR

The motor is totally enclosed, natural cooled and flameproof, designed for above deck mounting. Test - and Ex certificates are delivered with each motor.

CLASSIFICATION SOCIETIES

The fan satisfy the demands of the various classification societies.

ACCESSORIES

- Contra flange
- Cable gland
- Equipment for vibration- and temperature monitoring
- Spare parts for gas tight assembly
- Tools for mounting/demounting of impeller

N Y B O R G A S

N-6230 SYKKYLVEN, NORWAY
TEL +47 70 25 40 80 - FAX +47 70 25 29 08
office@nyborgfan.com - www.nyborgfan.com



PUMP ROOM FAN FOR EXPLOSIVE FUMES

TYPE
PPV-D10X



APPLICATIONS

Typical application for this fan is mechanical ventilation of hazardous zones and rooms onboard ships. Duct-top, above deck mounting.

DESIGN

The PPV-D10X is designed primary for ventilation, both supply and extraction, of pumpRooms and other places where explosive fumes occur. The fan is spark proof with a totally enclosed, natural cooled and flameproof electric motor.

Long experience has contributed to a simple construction, with only one rotating part in addition to the motor itself. The propeller is mounted directly to the motor shaft, thus making it one unit with the motor flange, which can be lifted out for inspection.

EXECUTION

Fan casing consists of welded steel plates of heavy duty design and includes guiding vanes for the propeller.

The propeller and guiding plate are made of salt- and ammoniareistant aluminium, aerodynamically shaped and balanced.

The wire mesh guard is made of stainless steel.

Greasing-point for the gas tight assembly is provided on top of the cowl.

The PPV-D10X can be delivered in the range **from size no 260 to size no 1250**.

ELECTRIC MORTOR

The motor is totally enclosed, natural cooled and flameproof, designed for above deck mounting. Test - and Ex certificates are delivered with each motor.

CLASSIFICATION SOCIETIES

The fan satisfy the demands of the various classification societies.

ACCESSORIES

- Countra flange

N Y B O R G A S

N-6230 SYKKYLVEN, NORWAY
TEL +47 70 25 40 80 - FAX +47 70 25 29 08
office@nyborgfan.com - www.nyborgfan.com



Dimension drawing

PUV -
D1RX

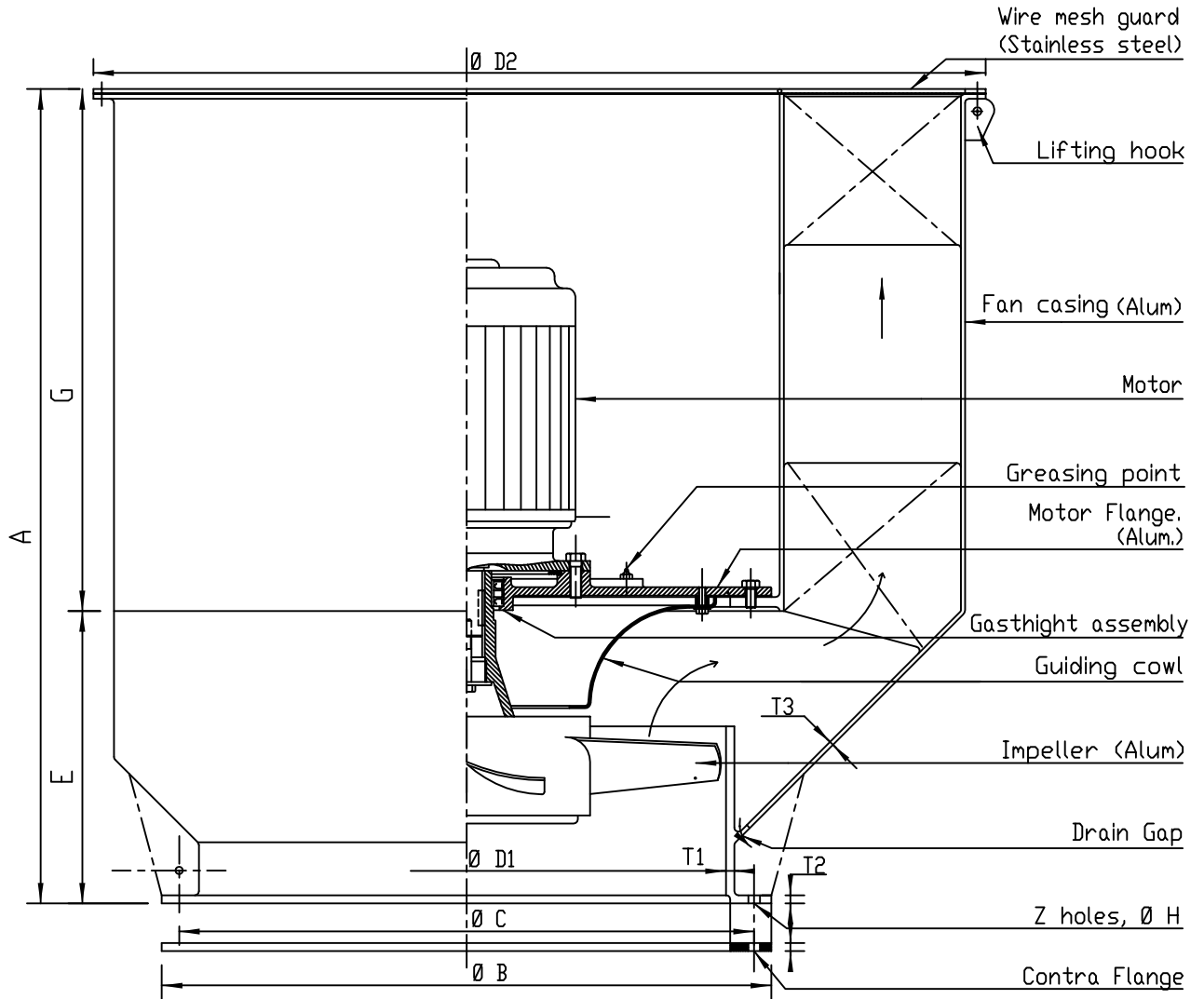

Size	A	ØB	ØC	D1	D2	E	G	T1	T2	T3	Z	H	Weight fan [kg]
260	600	337	310	260	650	255	345	8	10	4	8	12	32
300	600	387	360	300	680	255	345	8	10	4	8	14	36
350	650	437	405	350	800	300	350	8	10	4	8	14	43
400	730	488	460	400	850	310	420	8	10	4	12	14	54
450	850	548	510	450	960	335	515	8	10	4	12	14	65
500	900	598	560	500	1010	380	520	8	10	4	12	14	76
550	920	660	630	550	1160	400	520	10	10	4	16	14	
630	1050	740	698	630	1250	410	640	10	10	5	16	14	124
700	1150	810	775	700	1460	510	640	10	10	5	16	14	160
800	1180	912	870	800	1670	540	640	10	15	6	16	19	231
900	1380	1030	980	900	1870	615	765	10	15	6	16	19	312
1000	1470	1132	1080	1000	2070	705	765	10	15	6	20	19	

Dato: 09.01.04

Tegn.nr 4-1274

M.Berge

NYBORG AS

N-6239 SYKKYLVEN - NORWAY

Tlf: +47 70 25 40 80 - Fax +47 70 25 29 08 - NO 952 783 297 MVA

E-MAIL: office@nyborg-as.com - WEB: www.nyborg-as.com

PUV -
D1RX



Dimension drawing

PPV -
D10X

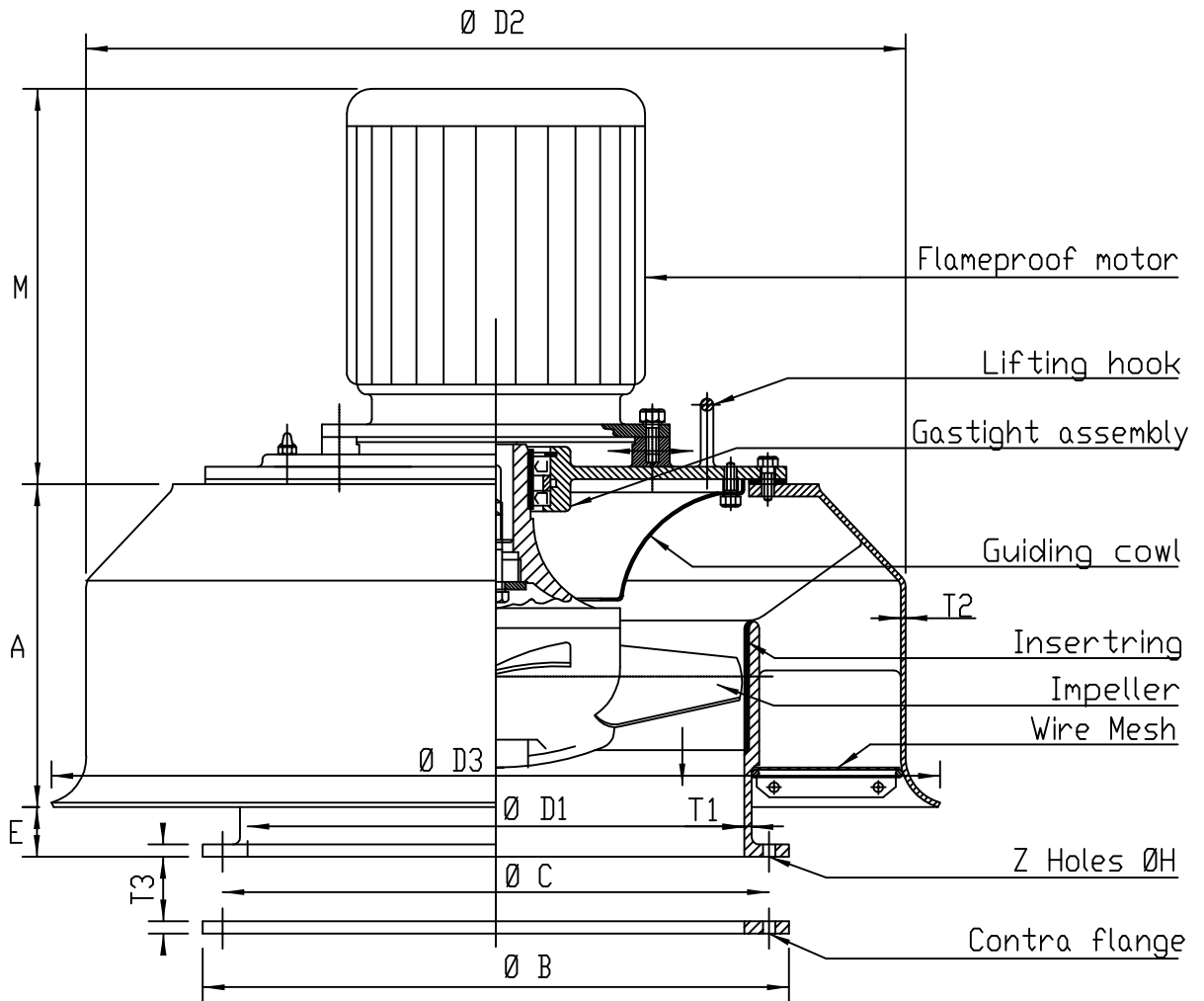

Size	A	ØB	ØC	Ø D1	Ø D2	Ø D3	E	T1	T2	T3	Z	H	Weight [kg] excl.motor
260	230	337	310	260	550	590	73	6	3	8	8	12	39
300	245	387	360	300	600	640	60	6	3	10	8	14	43
350	230	437	405	350	650	700	84	6	3	10	8	14	58
400	260	488	460	400	700	750	60	6	3	10	12	14	62
450	265	550	510	450	800	850	110	6	3	12	12	14	82
500	281	600	560	500	900	950	115	6	3	12	12	14	92
550	250	660	630	550	1000	1060	142	6	4	12	16	14	
630	352	740	698	630	1100	1160	150	6	4	12	16	14	163
700	447	810	775	700	1250	1300	135	6	4	12	16	14	227
800	470	912	870	800	1400	1480	135	6	5	12	16	19	300
900	505	1032	980	900	1600	1680	165	6	5	15	16	19	
1000	630	1232	1080	1000	1800	1900	178	6	5	15	20	19	
1250	750	1380	1320	1250	2250	2350	185	6	5	15	24	19	

Dato 08.07.97

Tegn.nr 4-1275

M.Berge

NYBORG AS

N-6239 SYKKYLVEN - NORWAY

Tlf: +47 70 25 40 80 - Fax +47 70 25 29 08 - NO 952 783 297 MVA

E-MAIL: office@nyborg-as.com - WEB: www.nyborg-as.com

PPV -
D10X



PRESSUREDROD IN COWLS PTV-PPV

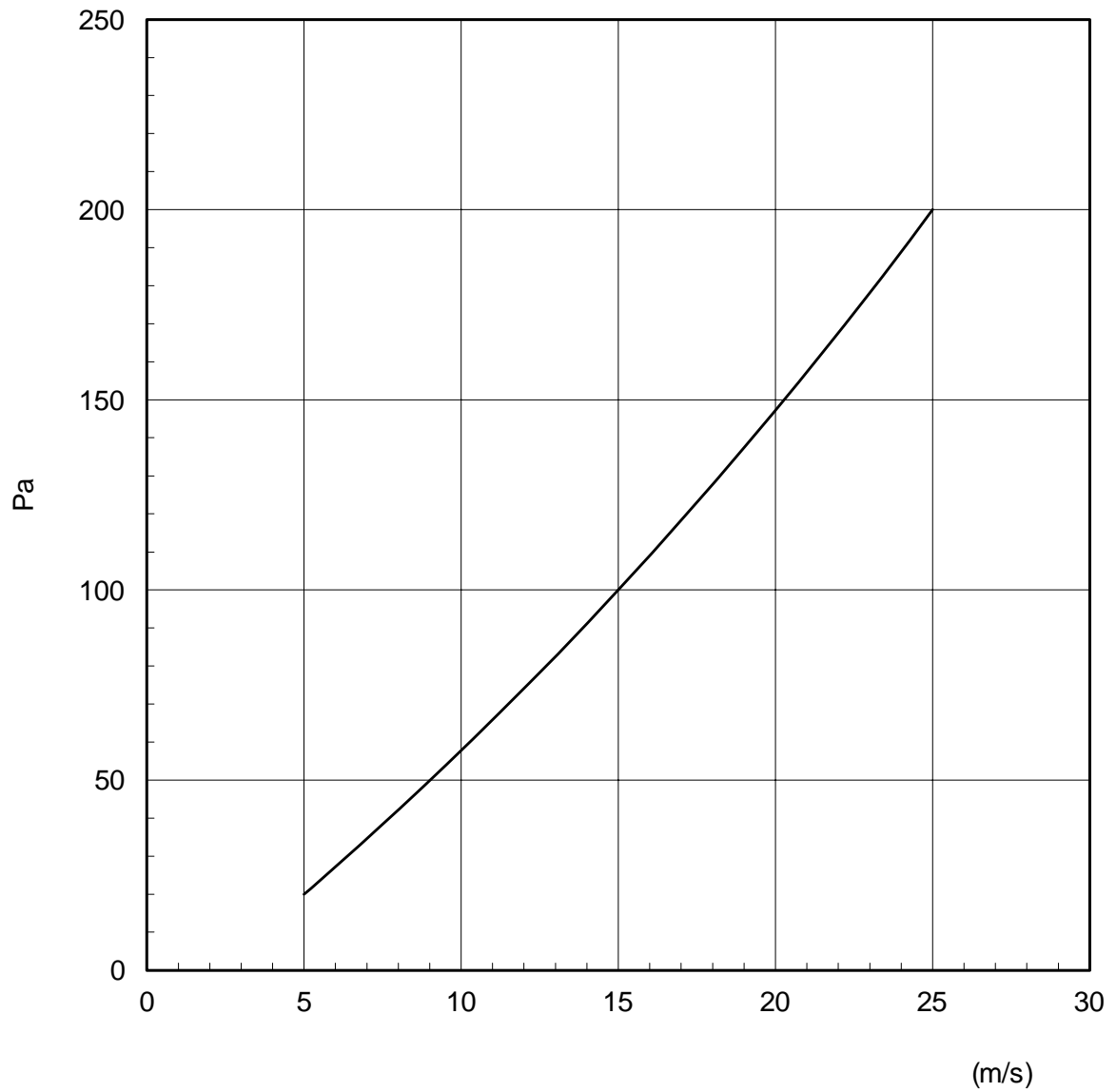

N Y B O R G A S

nyborg18.prs/4

N-6230 SYKKYLVEN, NORWAY
TEL +47 70 25 40 80 - FAX +47 70 25 29 08
E-mail : office@nyborgfan.com - www.nyborgfan.com



NYBORG AXIAL FLOW FAN PERFORMANCE DATA

**PPV/PUV
260**
Imp: D5/30-20

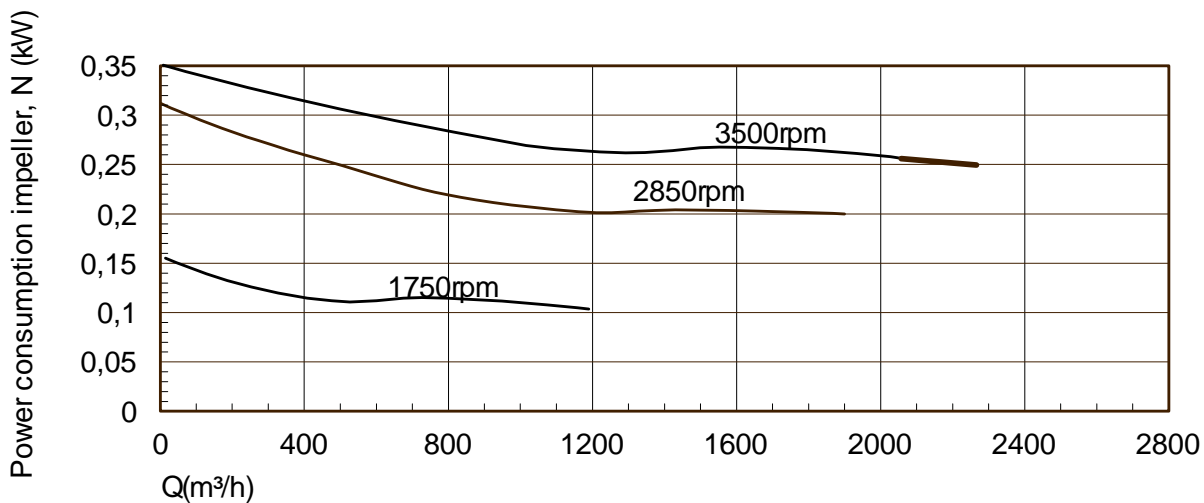
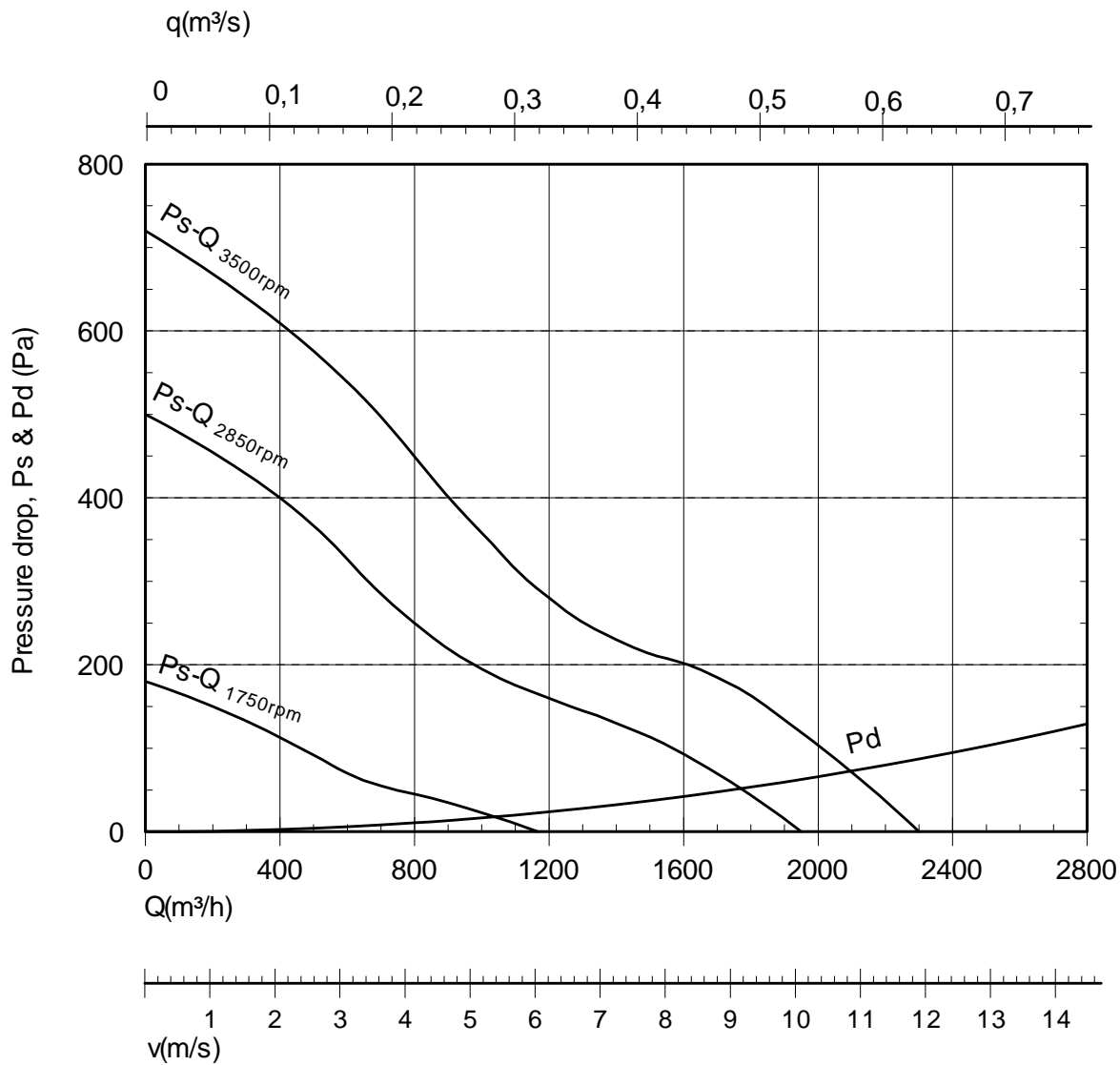

N Y B O R G A S

Nyborg9.prs/1

N-6230 SYKKYLVEN, NORWAY
TEL +47 70 25 40 80 - FAX +47 70 25 29 08
E-mail : office@nyborgfan.com - www.nyborgfan.com

**PPV/PUV
260**



NYBORG AXIAL FLOW FAN PERFORMANCE DATA

**PPV/PUV
300**
Imp: D5/30-20

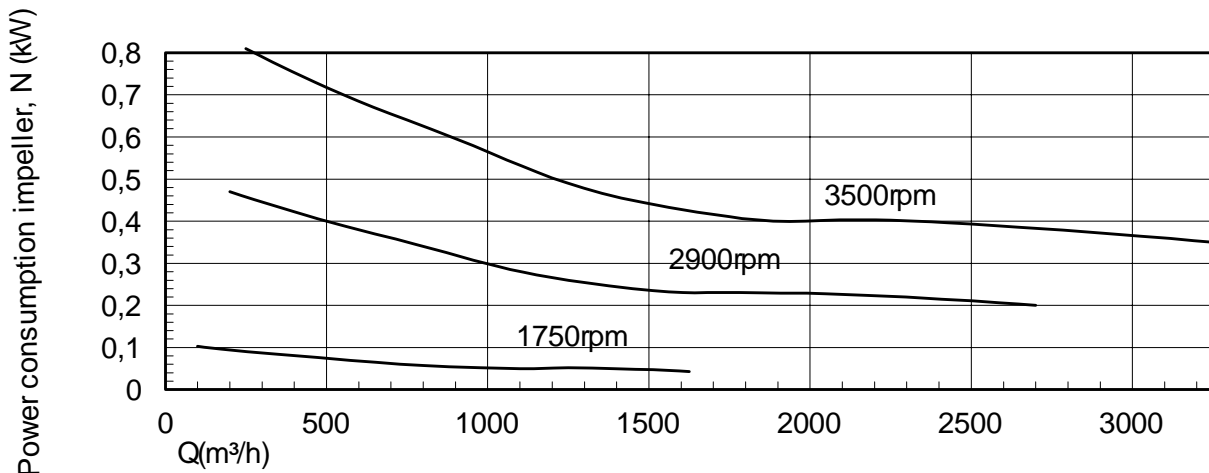
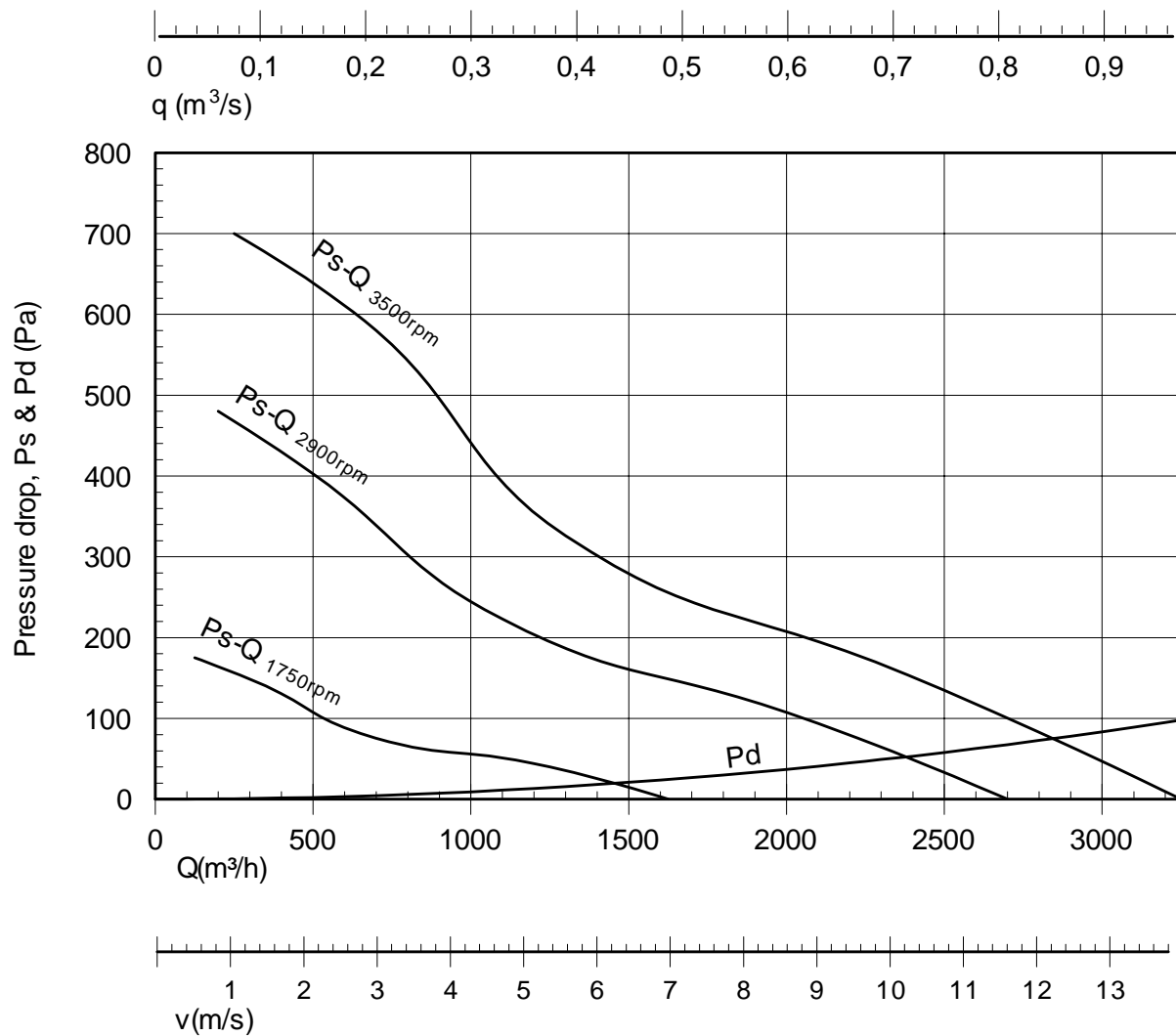

N Y B O R G A S

Nyborg9.prs/2

N-6230 SYKKYLVEN, NORWAY
TEL +47 70 25 40 80 - FAX +47 70 25 29 08
E-mail : office@nyborgfan.com - www.nyborgfan.com

**PPV/PUV
300**



NYBORG AXIAL FLOW FAN PERFORMANCE DATA

**PPV/PUV
350**
Imp: D5/30-20

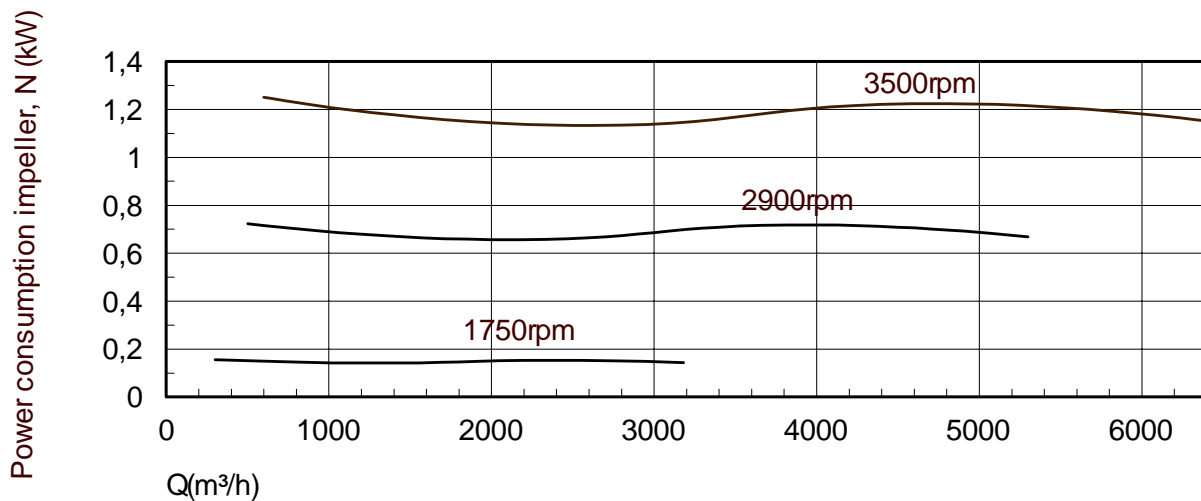
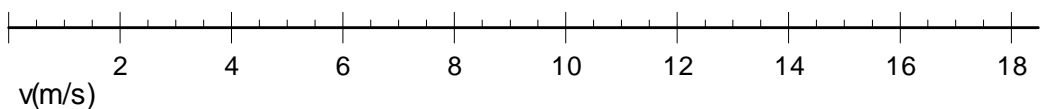
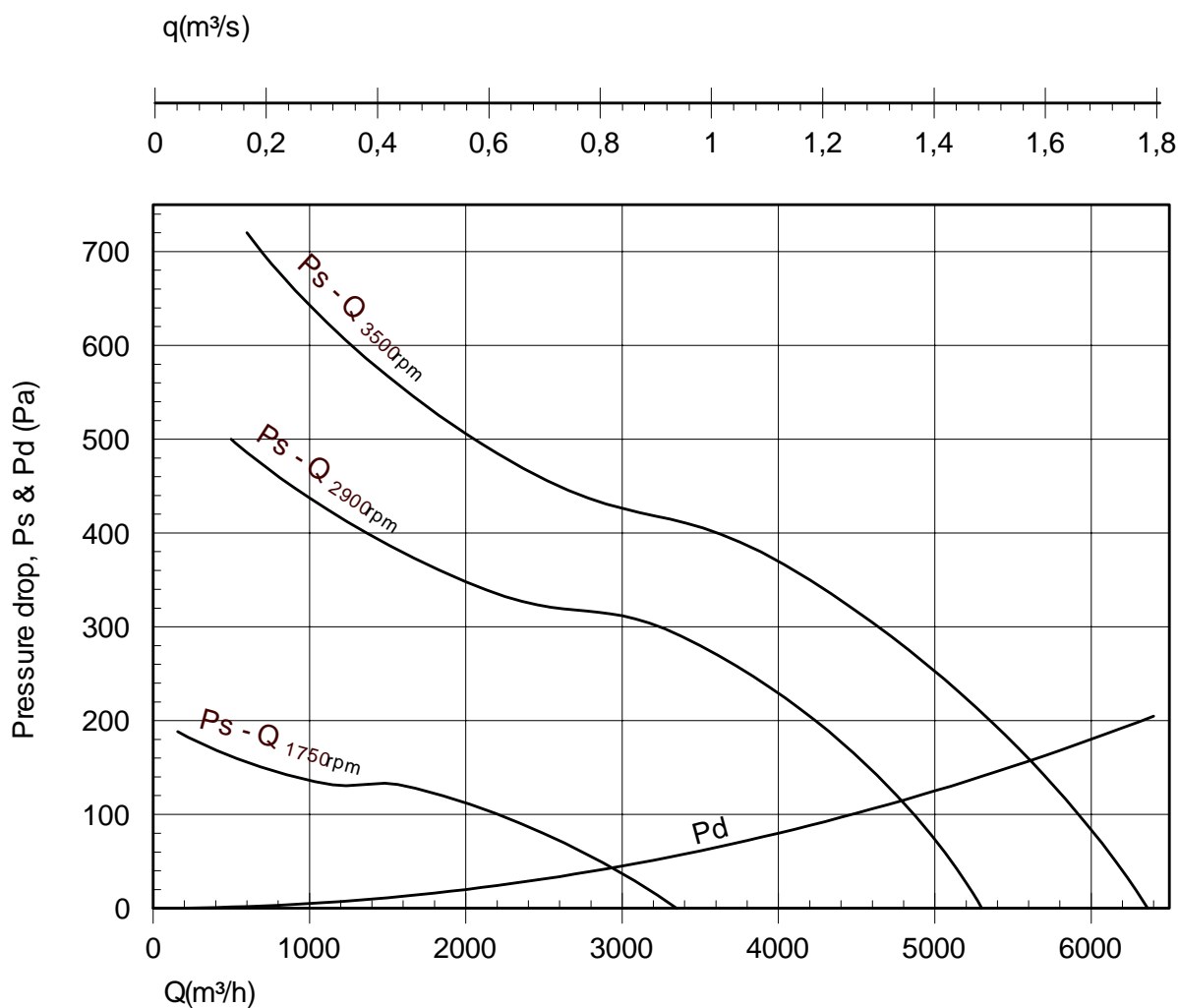

N Y B O R G A S

N-6230 SYKKYLVEN, NORWAY
TEL +47 70 25 40 80 - FAX +47 70 25 29 08
E-mail : office@nyborgfan.com - www.nyborgfan.com

**PPV/PUV
350**



NYBORG AXIAL FLOW FAN PERFORMANCE DATA

**PPV/PUV
400**
Imp: D5/30-20

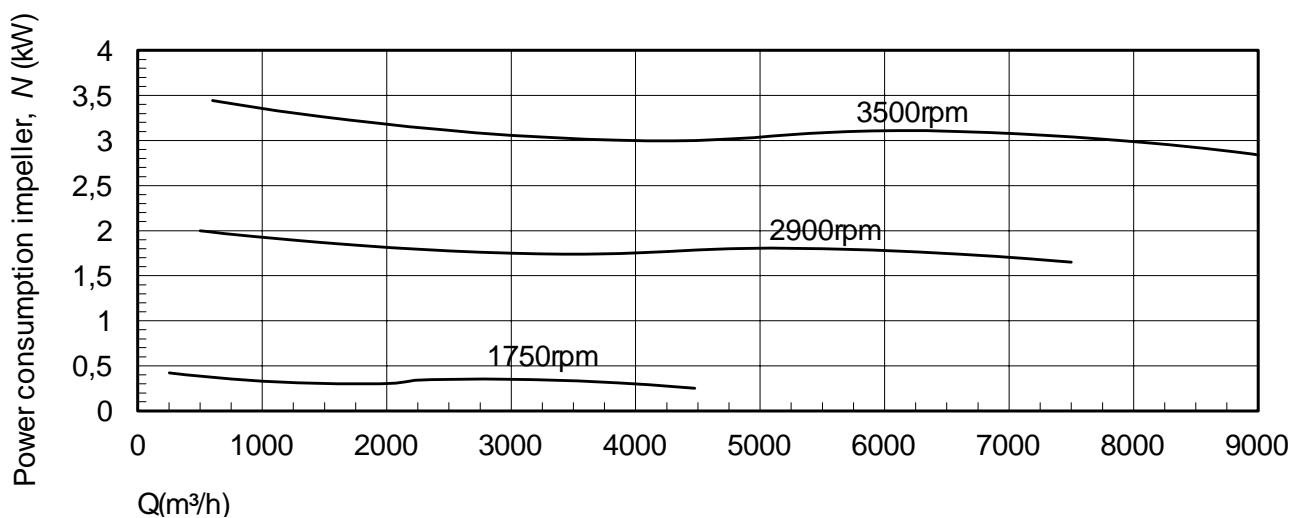
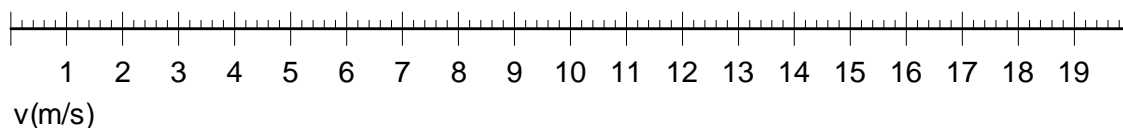
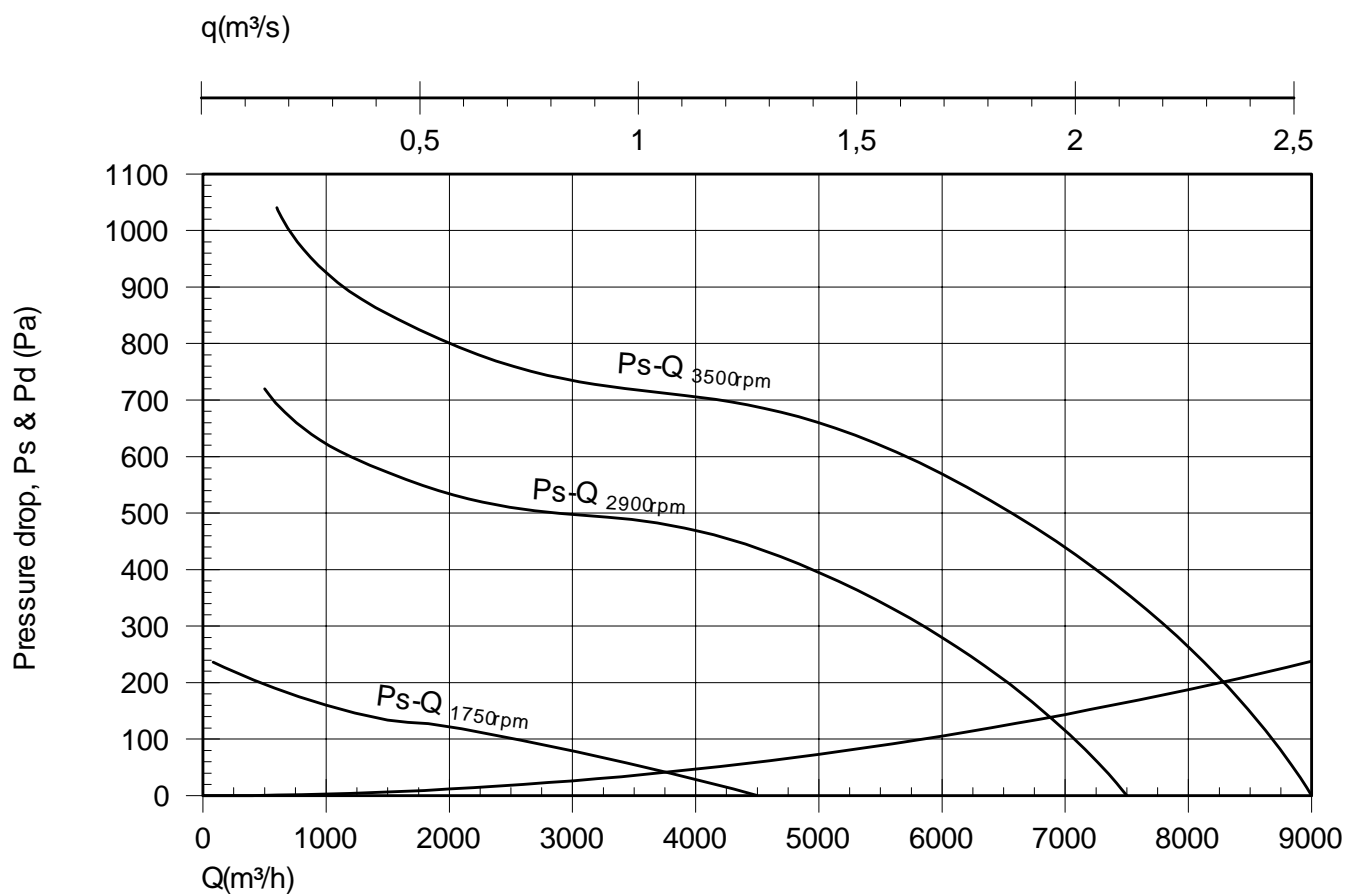

N Y B O R G A S

Nyborg9.prs/4

N-6230 SYKKYLVEN, NORWAY
TEL +47 70 25 40 80 - FAX +47 70 25 29 08
E-mail : office@nyborgfan.com - www.nyborgfan.com

**PPV/PUV
400**



NYBORG AXIAL FLOW FAN PERFORMANCE DATA

**PPV/PUV
450**
Imp: D7/30-20

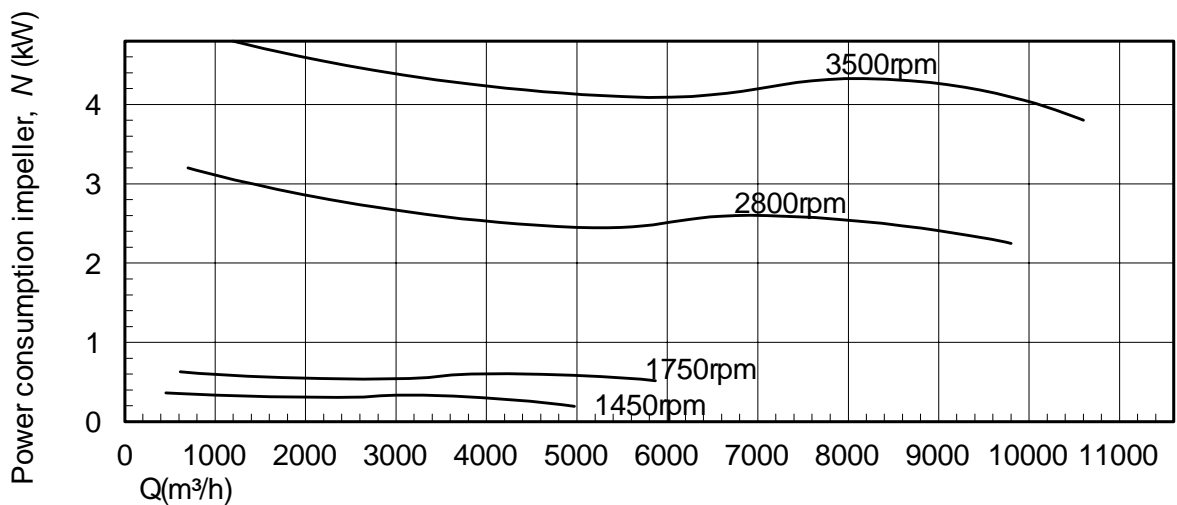
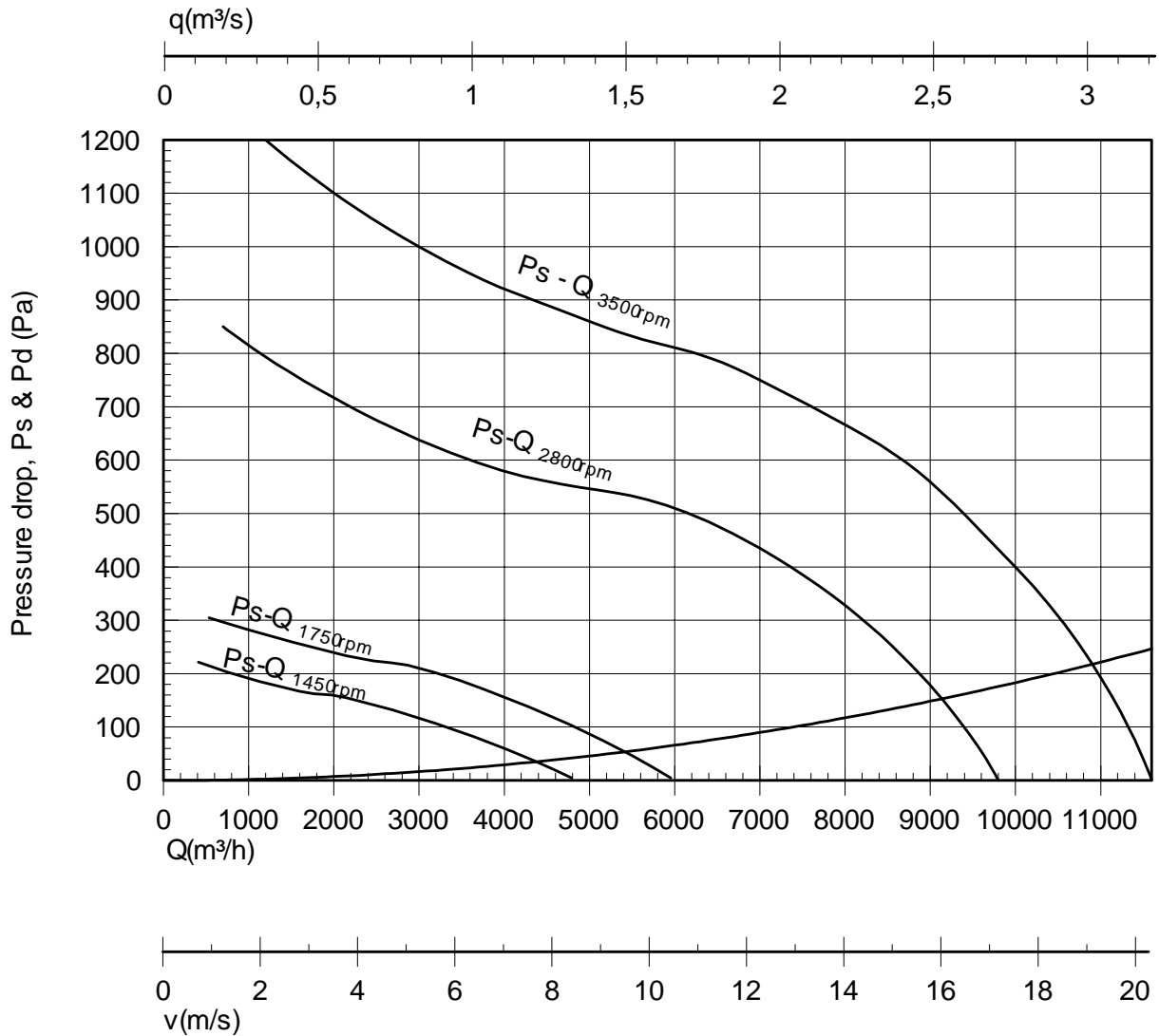

N Y B O R G A S

Nyborg9.prs/5

N-6230 SYKKYLVEN, NORWAY
TEL +47 70 25 40 80 - FAX +47 70 25 29 08
E-mail : office@nyborgfan.com - www.nyborgfan.com

**PPV/PUV
450**



NYBORG AXIAL FLOW FAN PERFORMANCE DATA

**PPV/PUV
500**
Imp: D8/30-20

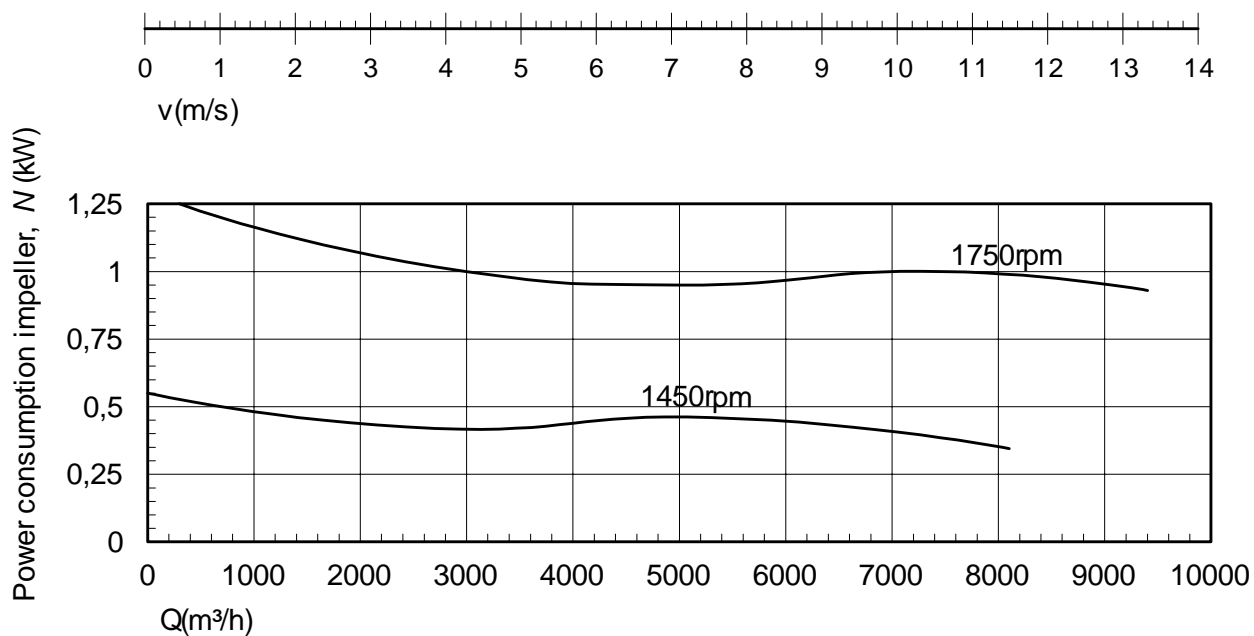
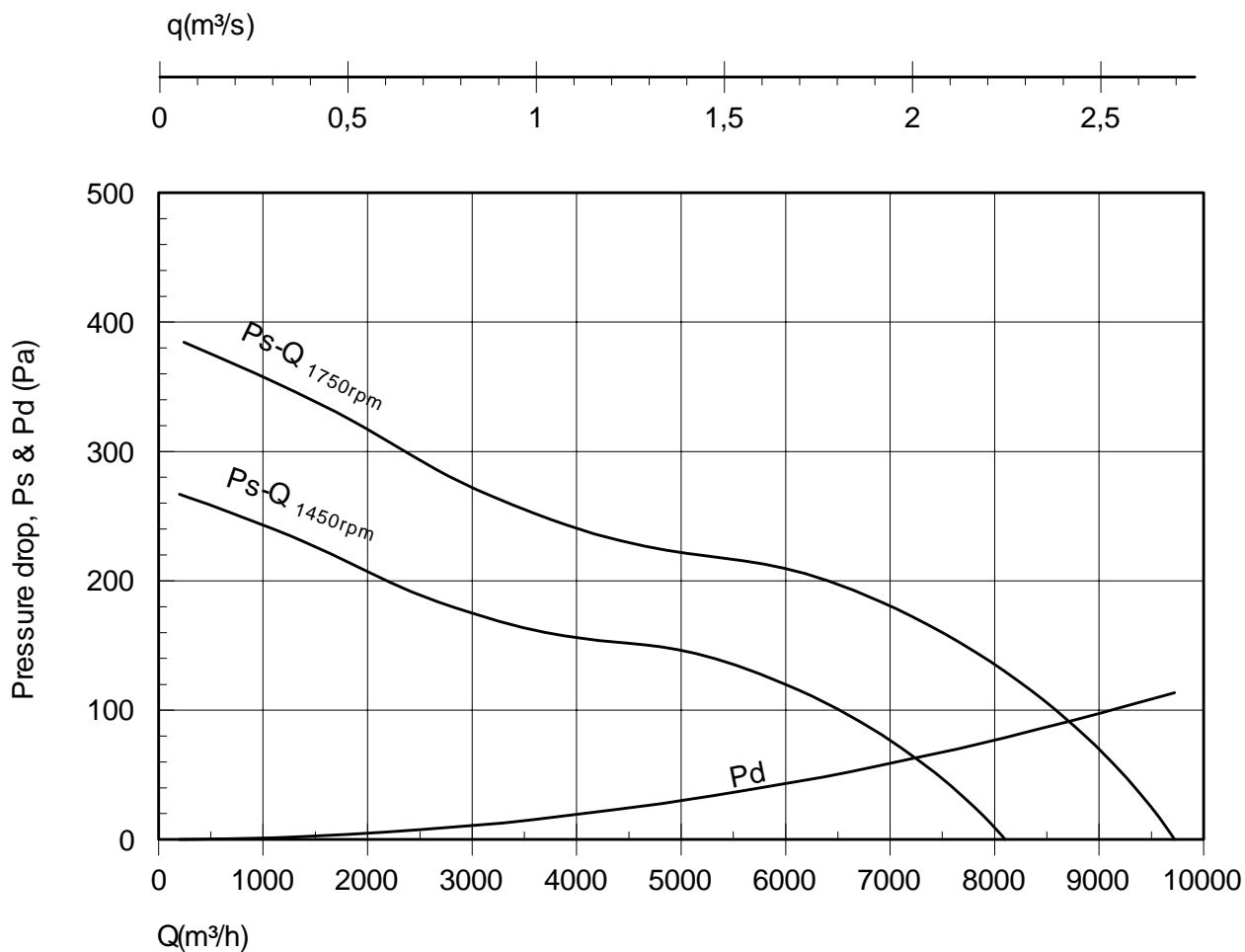

N Y B O R G A S

NYBORG09-21

N-6230 SYKKYLVEN, NORWAY
TEL +47 70 25 40 80 - FAX +47 70 25 29 08
E-mail : office@nyborgfan.com - www.nyborgfan.com

**PPV/PUV
500**



NYBORG AXIAL FLOW FAN PERFORMANCE DATA

**PPV/PUV
630**
Imp: D8/30-20

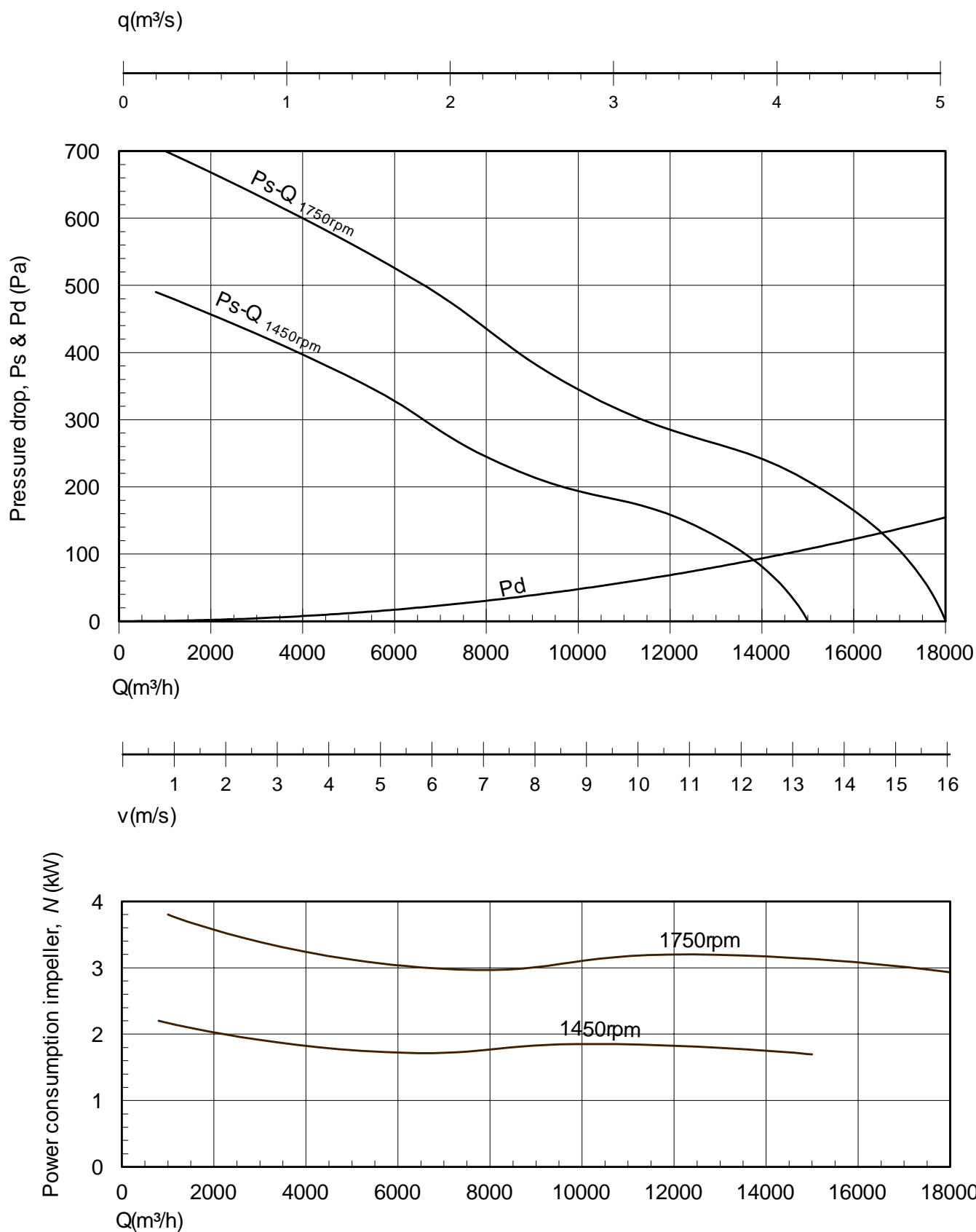

N Y B O R G A S

Nyborg9.prs/8

N-6230 SYKKYLVEN, NORWAY
TEL +47 70 25 40 80 - FAX +47 70 25 29 08
E-mail : office@nyborgfan.com - www.nyborgfan.com

**PPV/PUV
630**



NYBORG AXIAL FLOW FAN PERFORMANCE DATA

**PPV/PUV
700**
Imp: D8/30-20

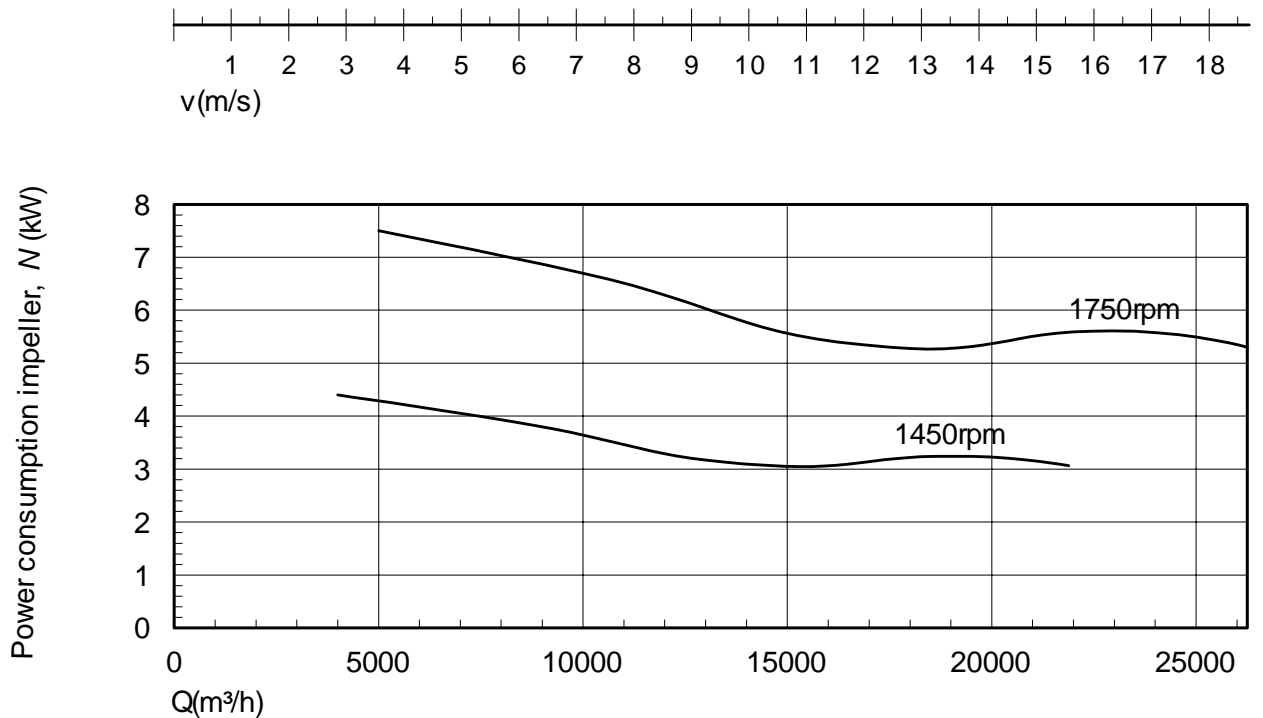
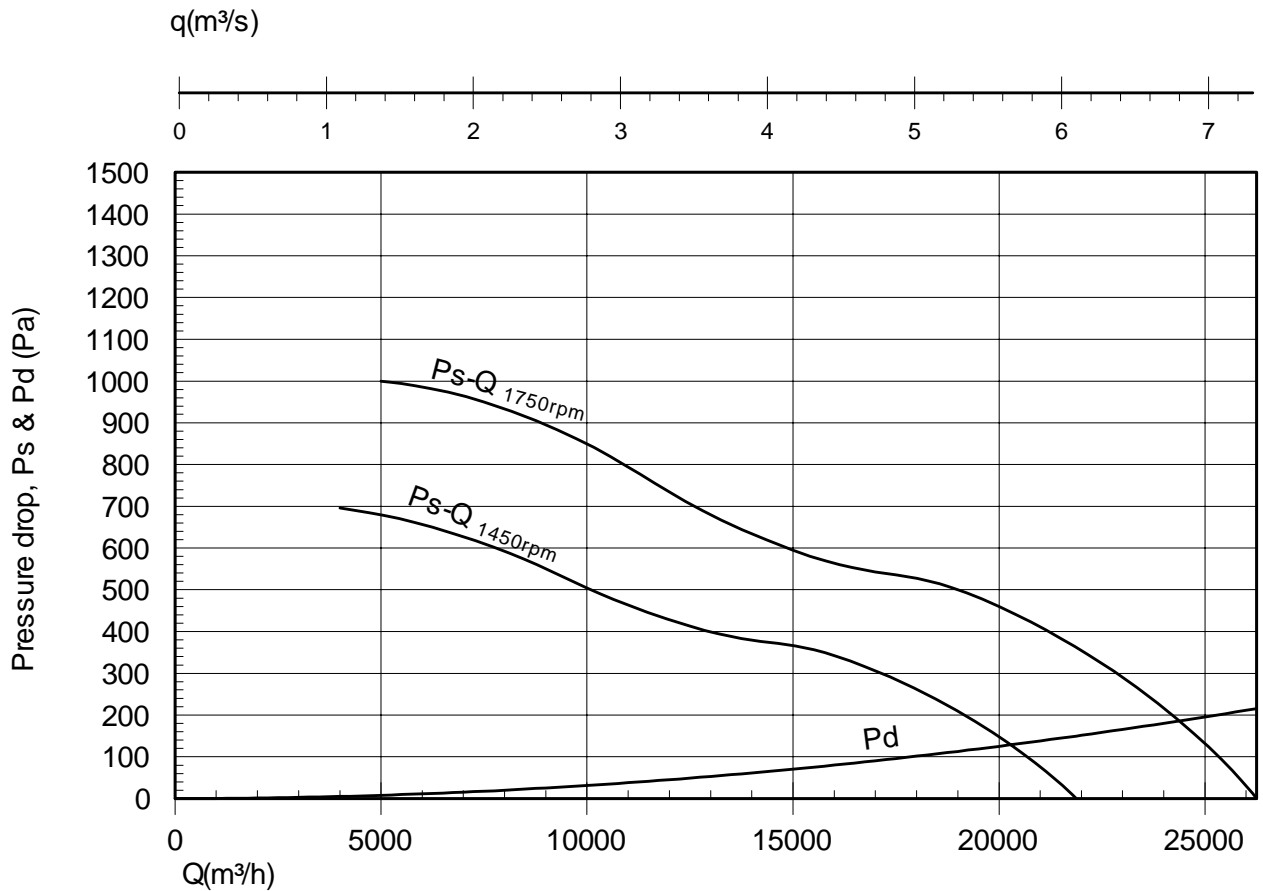

N Y B O R G A S

Nyborg9.prs/9

N-6230 SYKKYLVEN, NORWAY
TEL +47 70 25 40 80 - FAX +47 70 25 29 08
E-mail : office@nyborgfan.com - www.nyborgfan.com

**PPV/PUV
700**



NYBORG AXIAL FLOW FAN PERFORMANCE DATA

**PPV/PUV
800**
Imp: D8/30-20

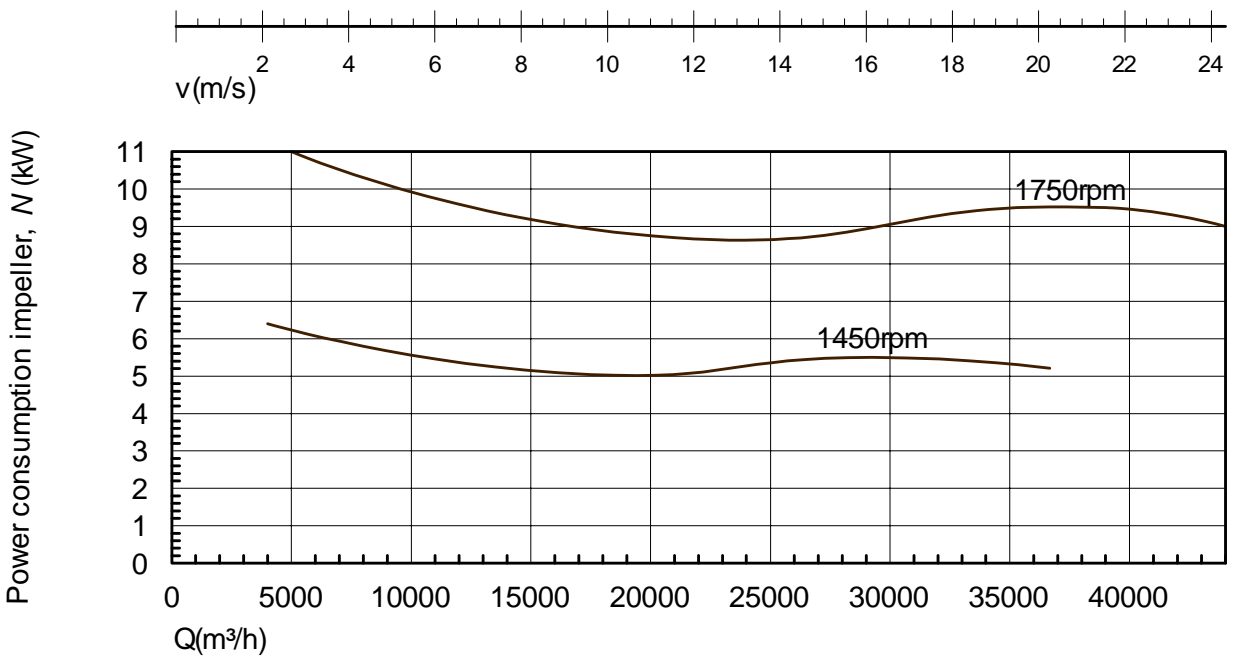
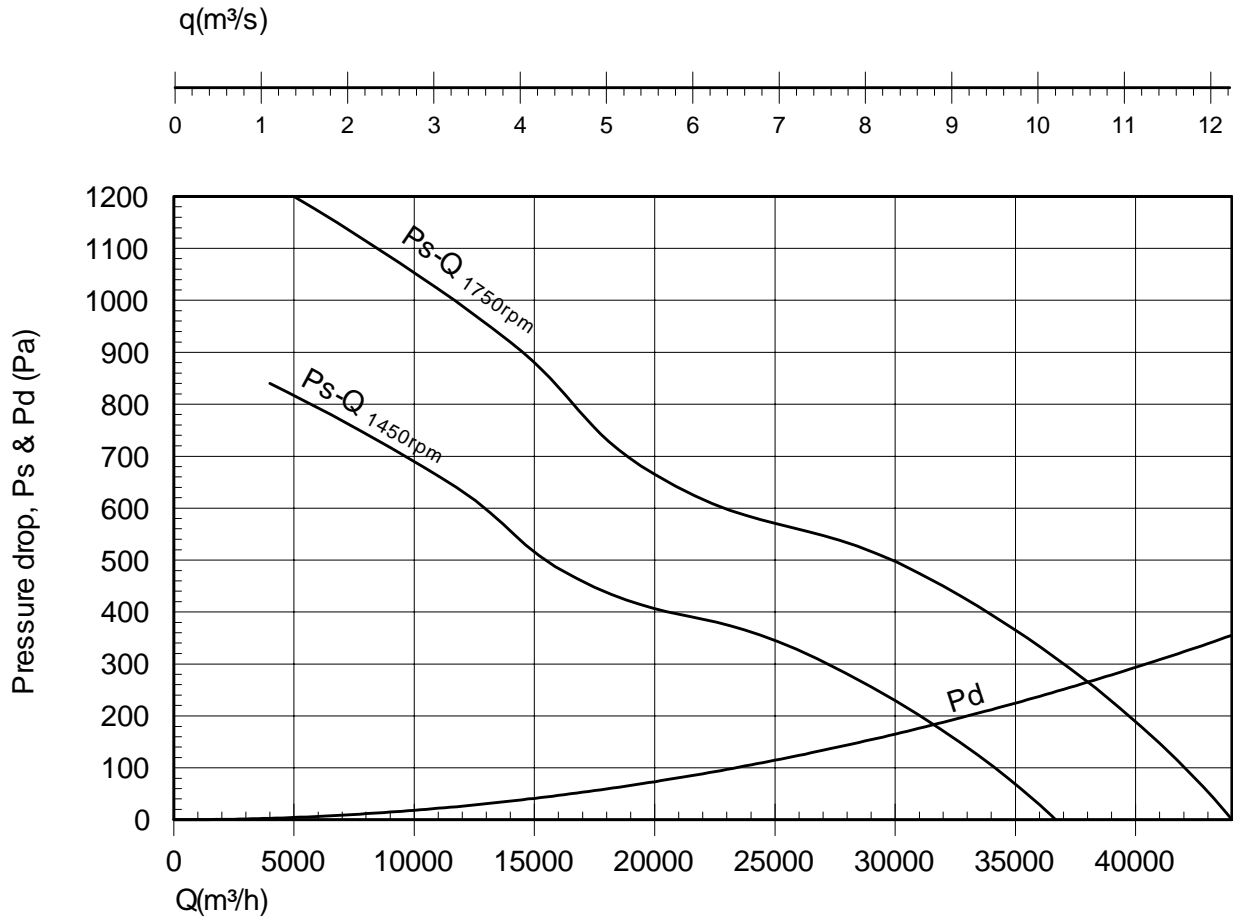

N Y B O R G A S

Nyborg9.prs/10

N-6230 SYKKYLVEN, NORWAY
TEL +47 70 25 40 80 - FAX +47 70 25 29 08
E-mail : office@nyborgfan.com - www.nyborgfan.com

**PPV/PUV
800**



NYBORG AXIAL FLOW FAN PERFORMANCE DATA

**PPV/PUV
900**
Imp: D10/17-27

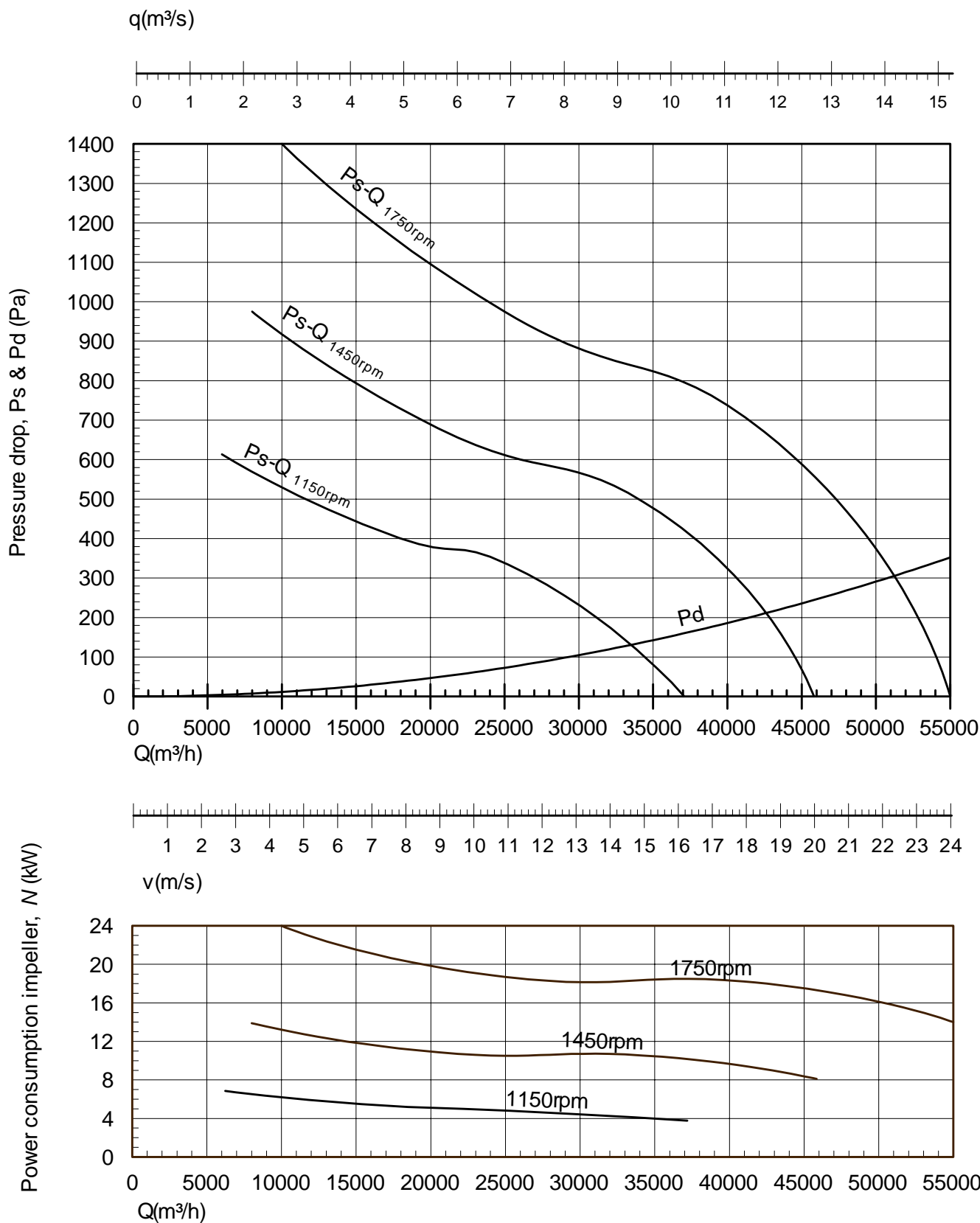

N Y B O R G A S

Nyborg9.prs/11

N-6230 SYKKYLVEN, NORWAY
TEL +47 70 25 40 80 - FAX +47 70 25 29 08
office@nyborgfan.com - www.nyborgfan.com

**PPV/PUV
900**



NYBORG AXIAL FLOW FAN PERFORMANCE DATA

**PPV/PUV
1000**
Imp: D10/20-30

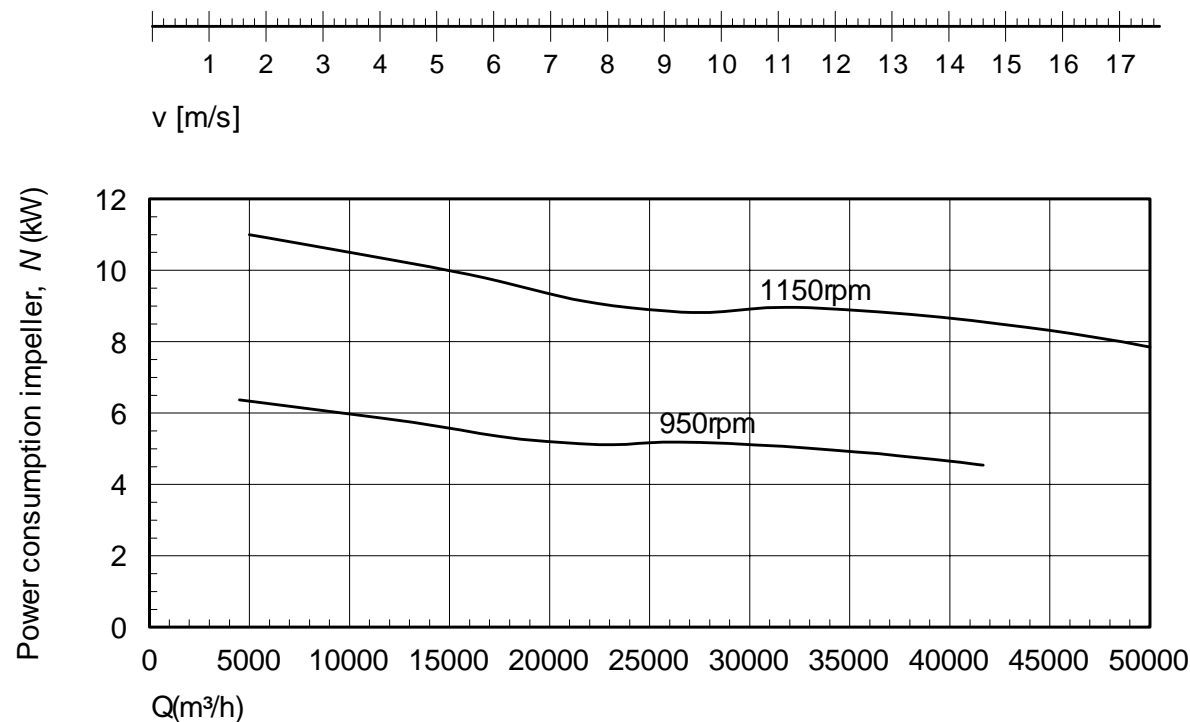
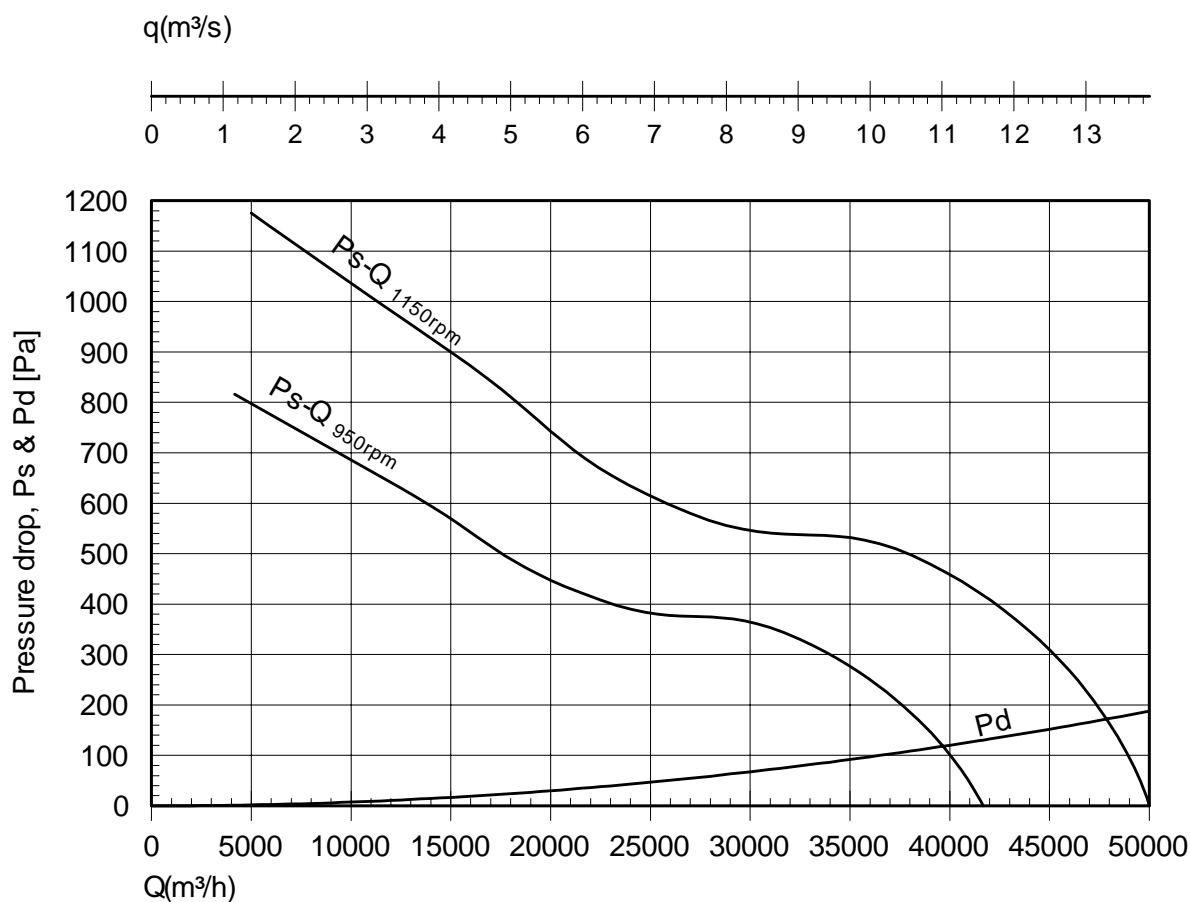

N Y B O R G A S

Nyborg10.prs/1

N-6230 SYKKYLVEN, NORWAY
TEL +47 70 25 40 80 - FAX +47 70 25 29 08
E-mail : office@nyborgfan.com - www.nyborgfan.com

**PPV/PUV
1000**



NYBORG AXIAL FLOW FAN PERFORMANCE DATA

**PPV/PUV
1100**

Imp: A7L / 16

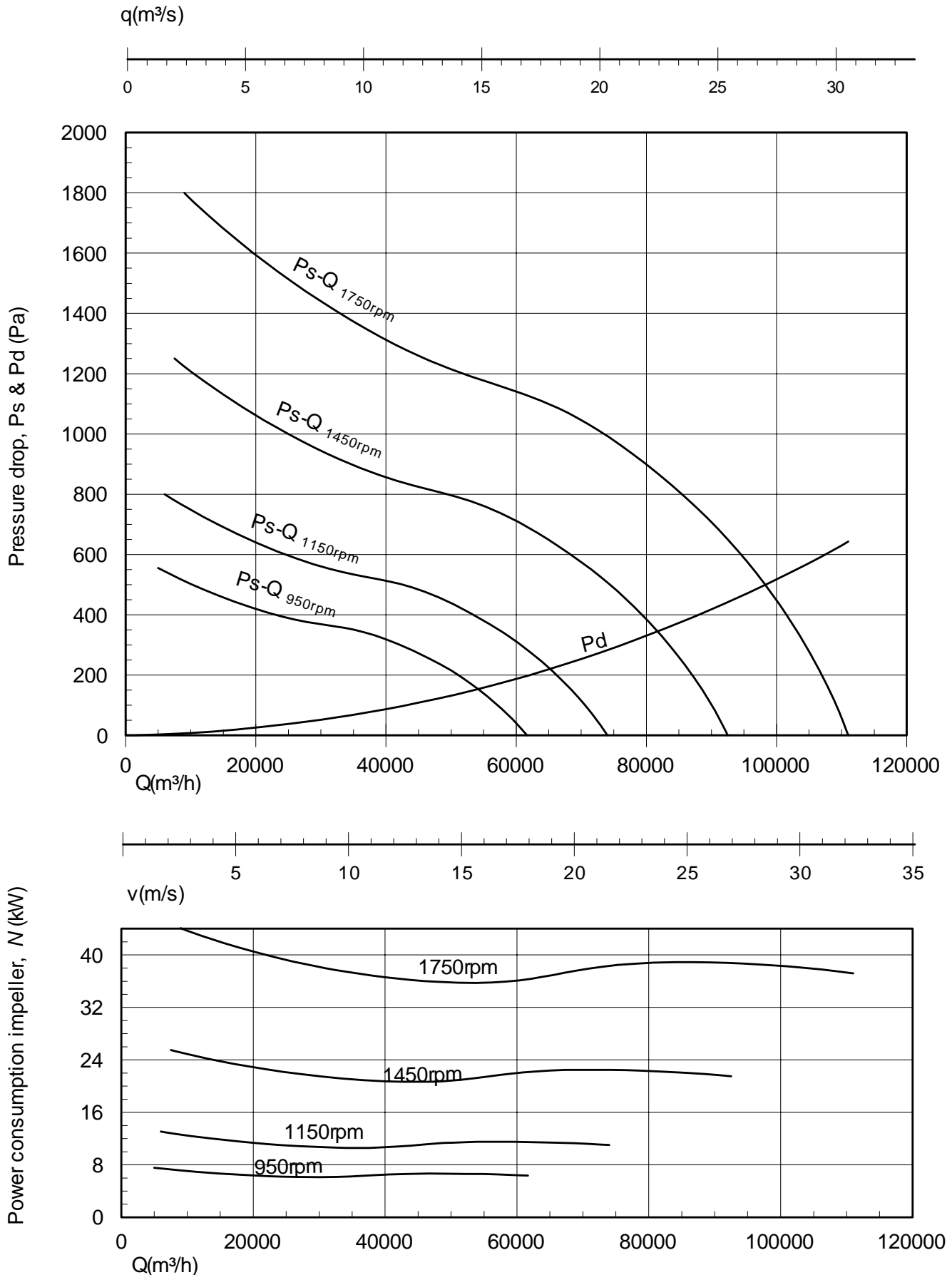

N Y B O R G A S

Nyborg09.prs/12

N-6230 SYKKYLVEN, NORWAY
TEL +47 70 25 40 80 - FAX +47 70 25 29 08
E-mail : office@nyborgfan.com - www.nyborgfan.com

**PPV/PUV
1100**



NYBORG AXIAL FLOW FAN PERFORMANCE DATA

**PPV/PUV
1250**

Imp: A9T / 21

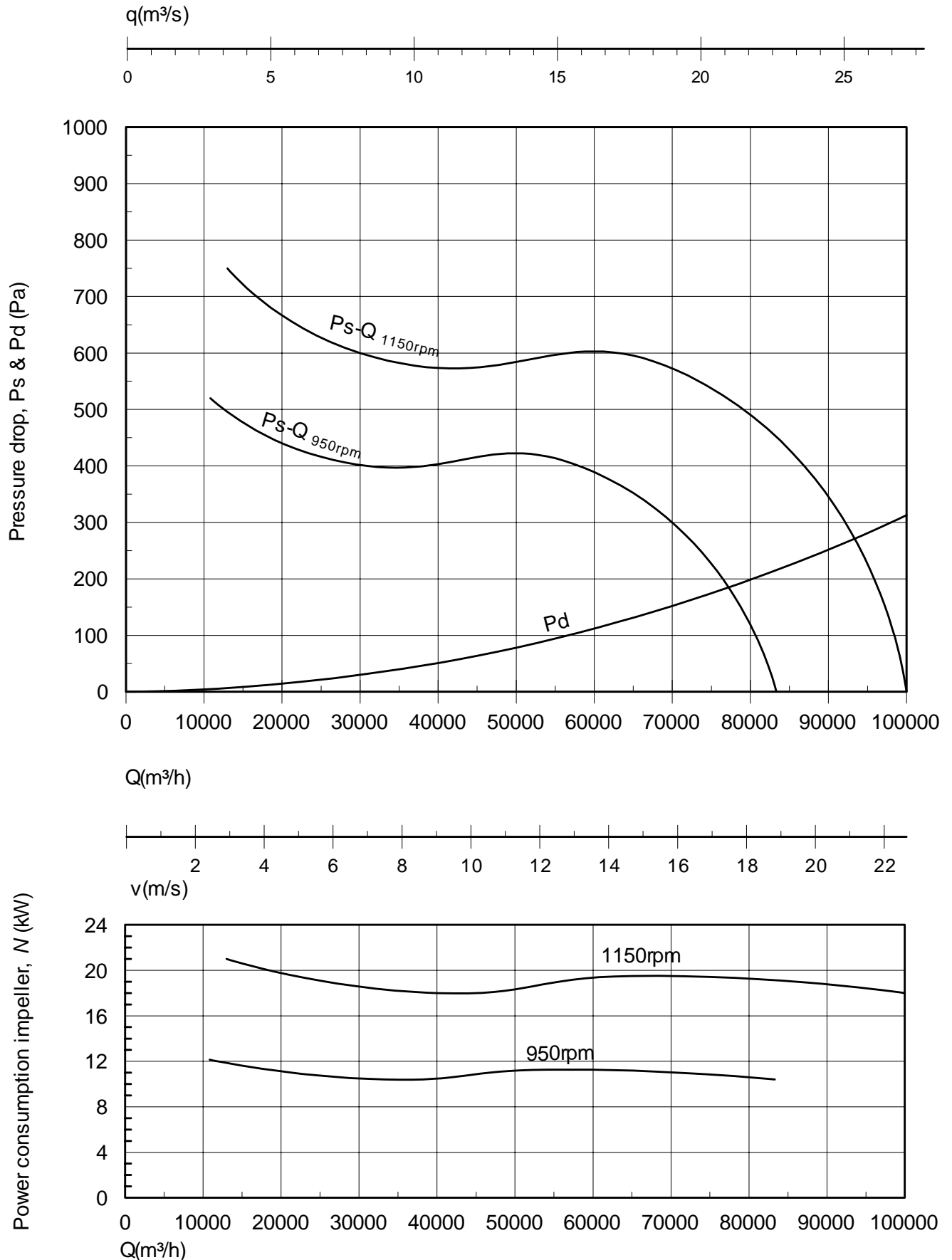

N Y B O R G A S

Nyborg09.prs/13

N-6230 SYKKYLVEN, NORWAY
TEL +47 70 25 40 80 - FAX +47 70 25 29 08
E-mail : office@nyborgfan.com - www.nyborgfan.com

**PPV/PUV
1250**



CENTRIFUGAL EXHAUST FAN FOR EXPLOSIVE FUMES

TYPE
SUV - 1RX



IMPELLER

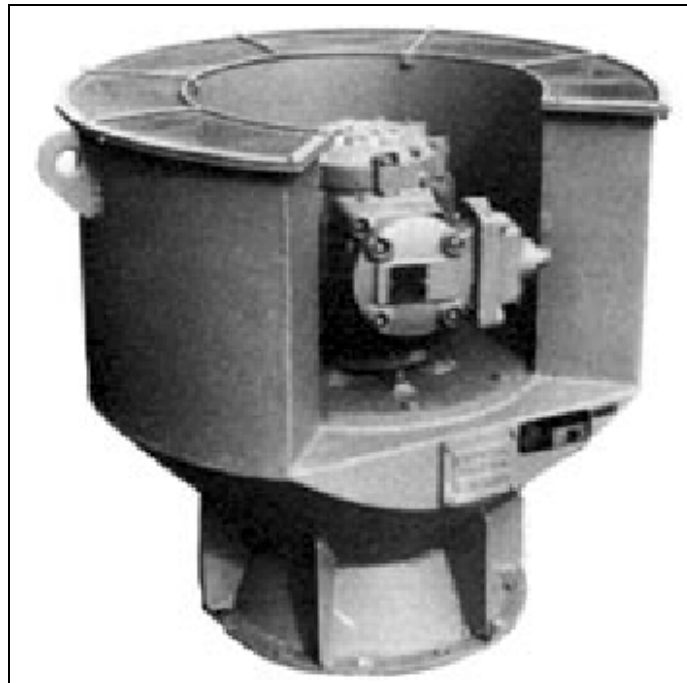

EQUIPMENT

NYBORG CENTRIFUGAL EXHAUST FAN

Is designed primarily for ventilation of pump-rooms and other places where explosive fumes occur. The fan is spark proof and designed for air extraction. Long experience has contributed to a simple construction with only one rotating part in addition to the motor itself. The impeller is mounted directly to the motorshaft, thus making one unit with the motorflange, which can be lifted out for inspection.

Fan casing and motorflange are made of salt- and ammoniaresistive aluminium.

The impeller is made of salt- and ammoniaresistive aluminium. It is aerodynamically shaped and balanced.

The wire mesh guard is made of stainless steel.

Greasing-point for the gastight assembly is provided on the top of the motorflange.

The motor is flameproof, totally enclosed, natural cooled and designed for above deck mounting.

Test certificates are delivered with each motor. Conter flange of steel for duct connection.

EQUIPMENT

Two spare sealing-rings for the gastight assembly, mounting- and demounting tools for the impeller and an instruction with data. The equipment is packed in a separate box.

Size No	A	B	C	D1	D2	E	F1	F2	G	Z	H	T	Weight less motor
200	560	270	242	200	550	220	10	8	340	8	12	5	
250	610	330	292	250	600	270	10	8	340	8	12	5	
300	610	390	360	300	680	270	10	10	340	8	14	6	
350	650	437	405	350	810	310	10	10	340	8	14	6	
400	805	488	460	400	860	380	10	10	425	12	14	6	
450	910	558	510	450	960	400	15	12	510	12	14	6	
500	890	609	560	500	1010	380	15	12	510	12	14	6	
550	910	660	630	550	1160	400	15	12	510	12	14	6	

N Y B O R G A S		
N-6230 SYKKYLVEN, NORWAY TEL +47 70 25 40 80 - FAX +47 70 25 29 08 E-mail : office@nyborgfan.com - www.nyborgfan.com		TYPE SUV - 1RX



Dimension drawing

SUV - 1RX

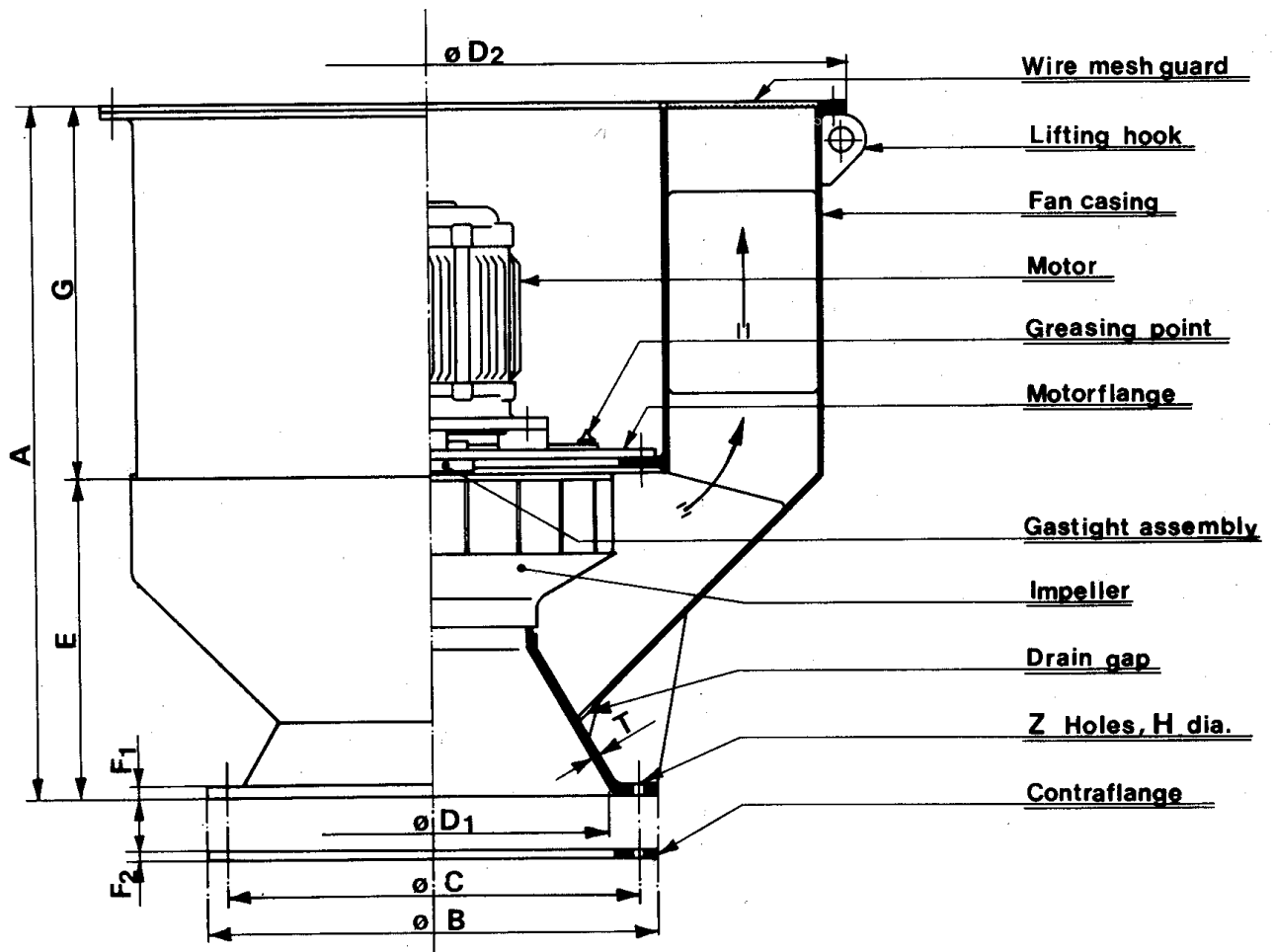

Size No	A	B	ØC	ØD1	ØD2	E	F1	F2	G	Z	H	T	Weight less motor
200	560	270	310	200	550	220	10	8	340	8	12	5	
250	610	330	292	250	600	270	10	8	340	8	12	5	
300	610	390	360	300	680	270	10	10	340	8	14	6	
350	650	437	405	350	810	310	10	10	340	8	14	6	
400	805	488	460	400	860	380	10	10	425	12	14	6	
450	910	558	510	450	960	400	15	12	510	12	14	6	
500	890	609	560	500	1010	380	15	12	510	12	14	6	
550	910	660	630	550	1160	400	15	12	510	12	14	6	
630	1050	740	698	630	1250	410	15	12	640	16	14	6	
800	1180	912	870	800	1670	540	15	12	640	16	19	10	

N Y B O R G A S

1-847

N-6230 SYKKYLVEN, NORWAY
 TEL +47 70 25 40 80 - FAX +47 70 25 29 08
 office@nyborgfan.com - www.nyborgfan.com

SUV - 1RX



CENTRIFUGAL EXHAUST FAN PERFORMANCE DATA

SUV 250 B

Imp: 260x82

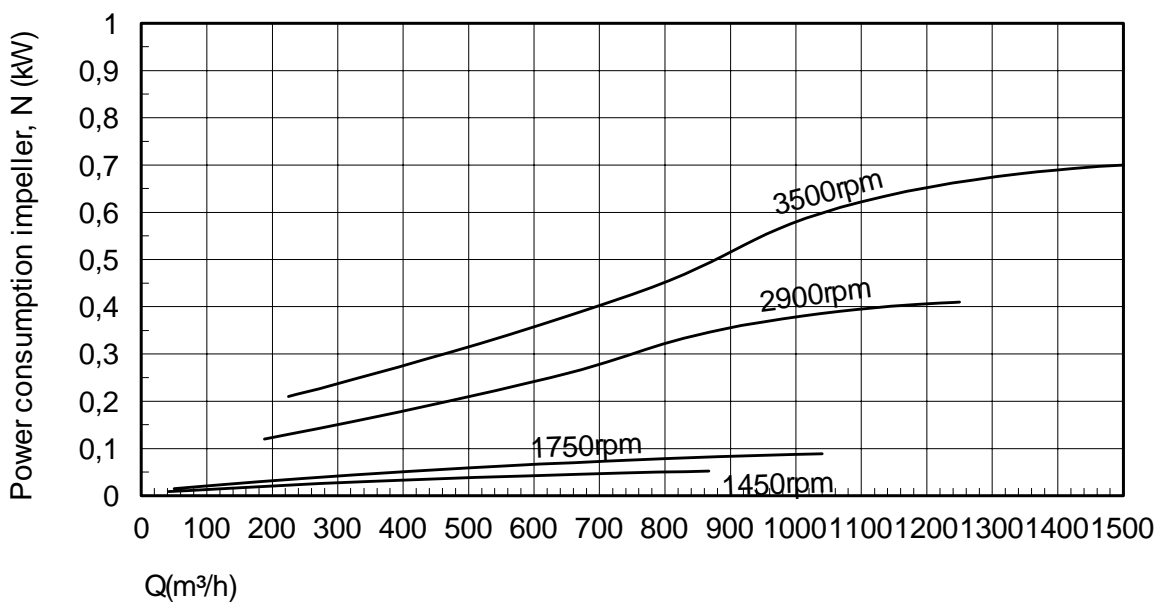
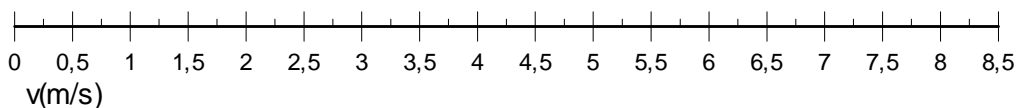
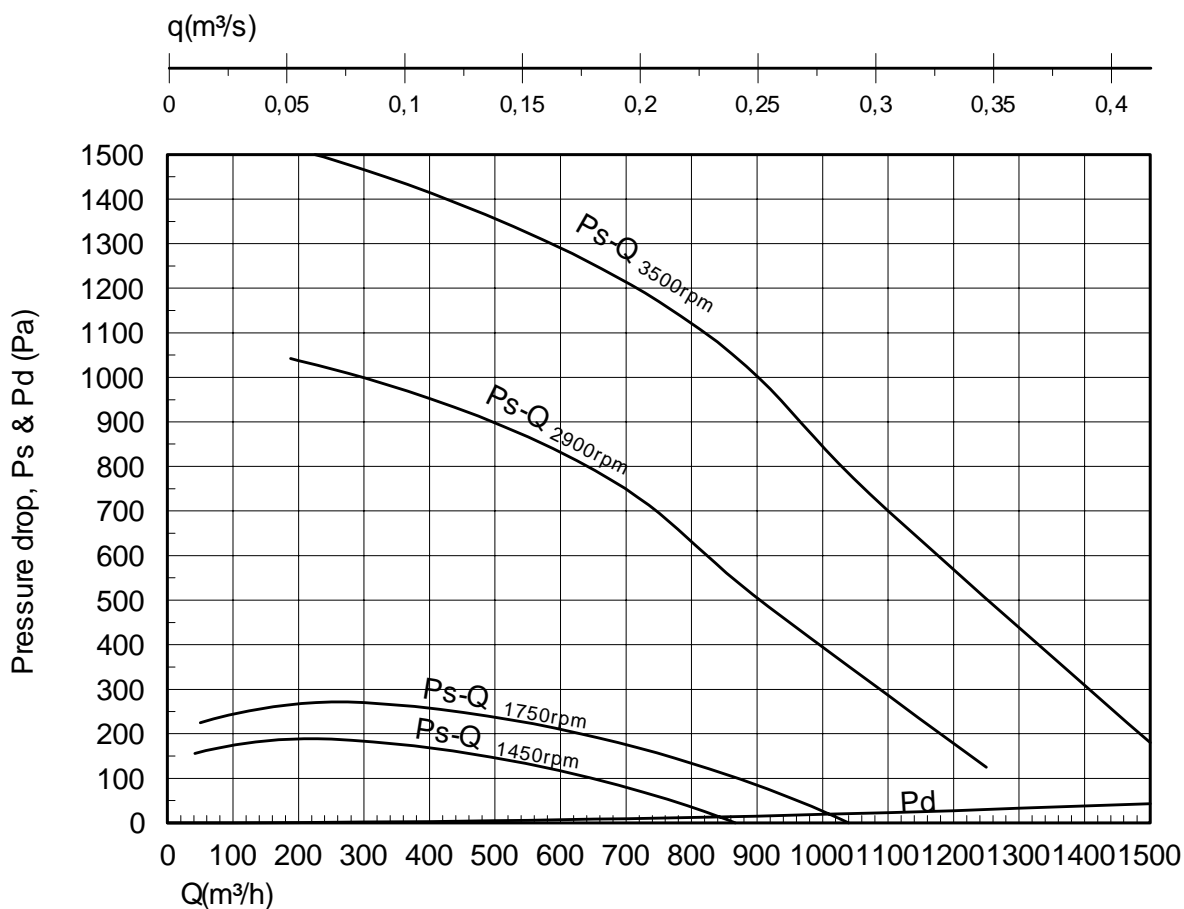

N Y B O R G A S

Nyborg17.prs/1

N-6230 SYKKYLVEN, NORWAY
TEL +47 70 25 40 80 - FAX +47 70 25 29 08
E-mail : office@nyborgfan.com - www.nyborgfan.com

SUV 250 B



CENTRIFUGAL EXHAUST FAN PERFORMANCE DATA

SUV 250 Z
Imp: 250x70

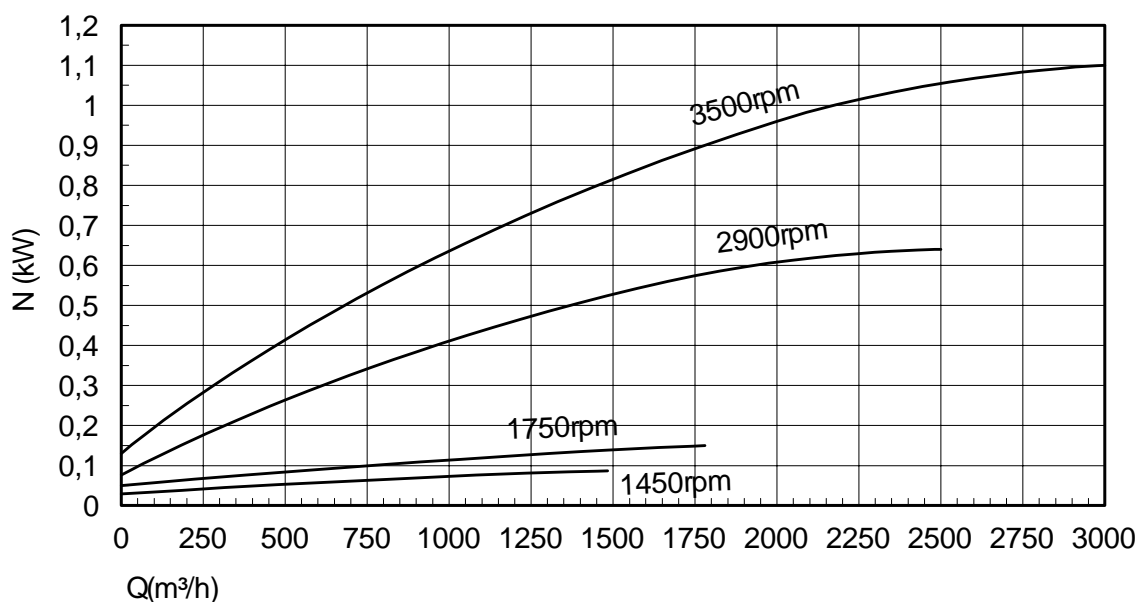
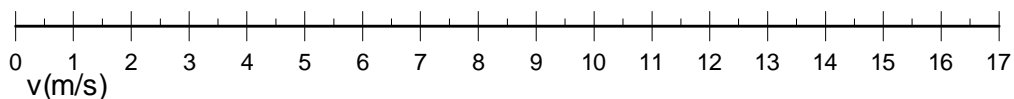
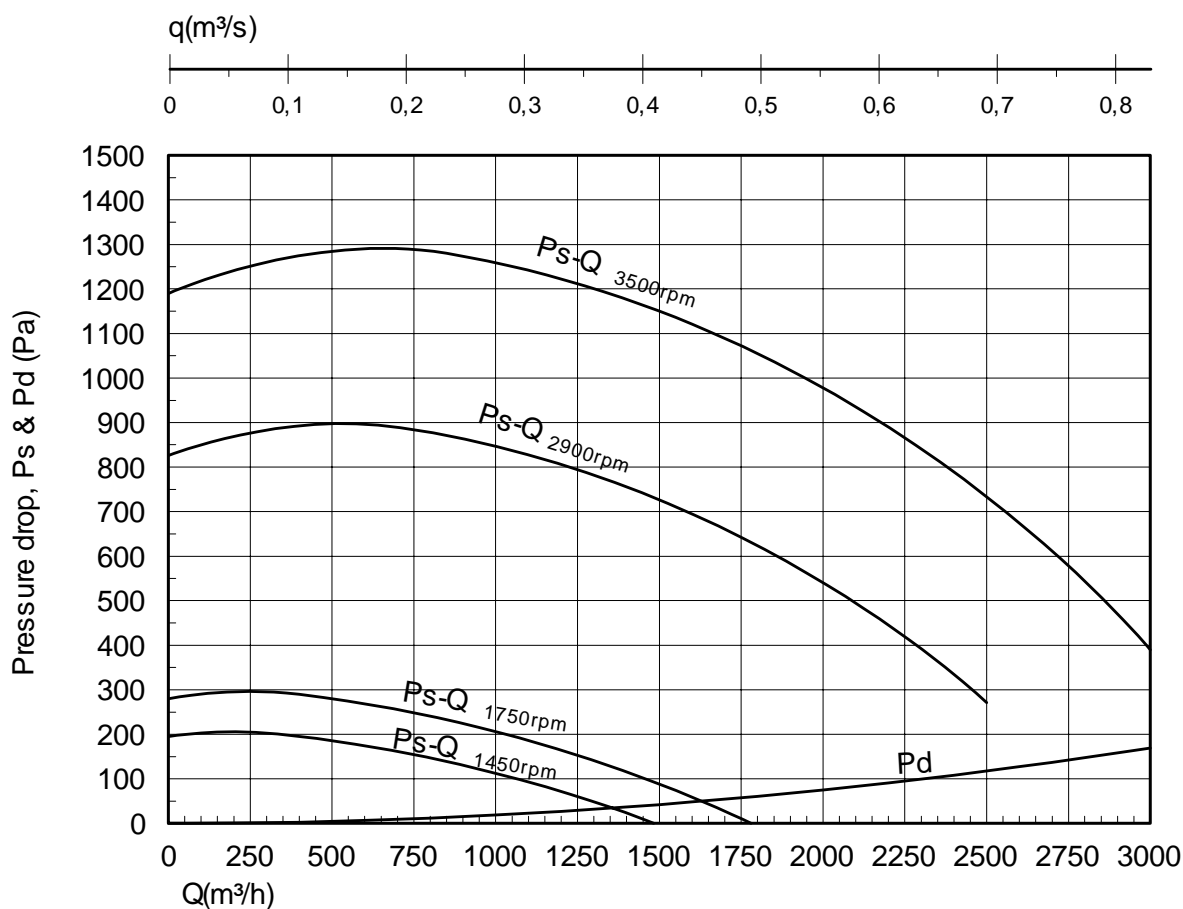

N Y B O R G A S

Nyborg17.prs/2

N-6230 SYKKYLVEN, NORWAY
TEL +47 70 25 40 80 - FAX +47 70 25 29 08
E-mail : office@nyborgfan.com - www.nyborgfan.com

SUV 250 Z



CENTRIFUGAL EXHAUST FAN PERFORMANCE DATA

SUV 300 Z
Imp: 310x70

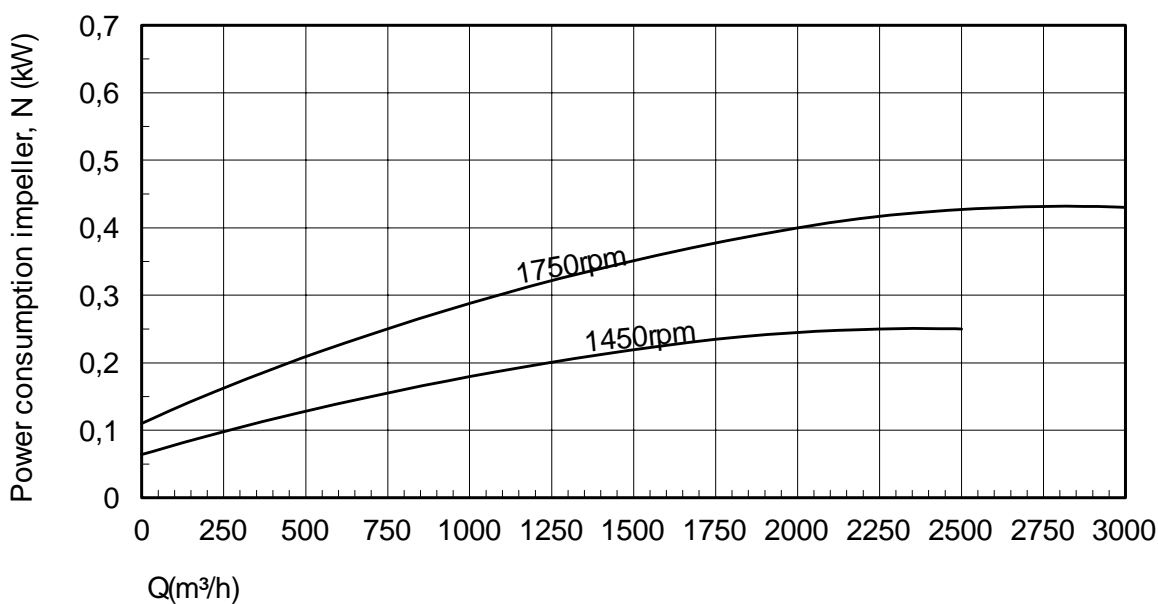
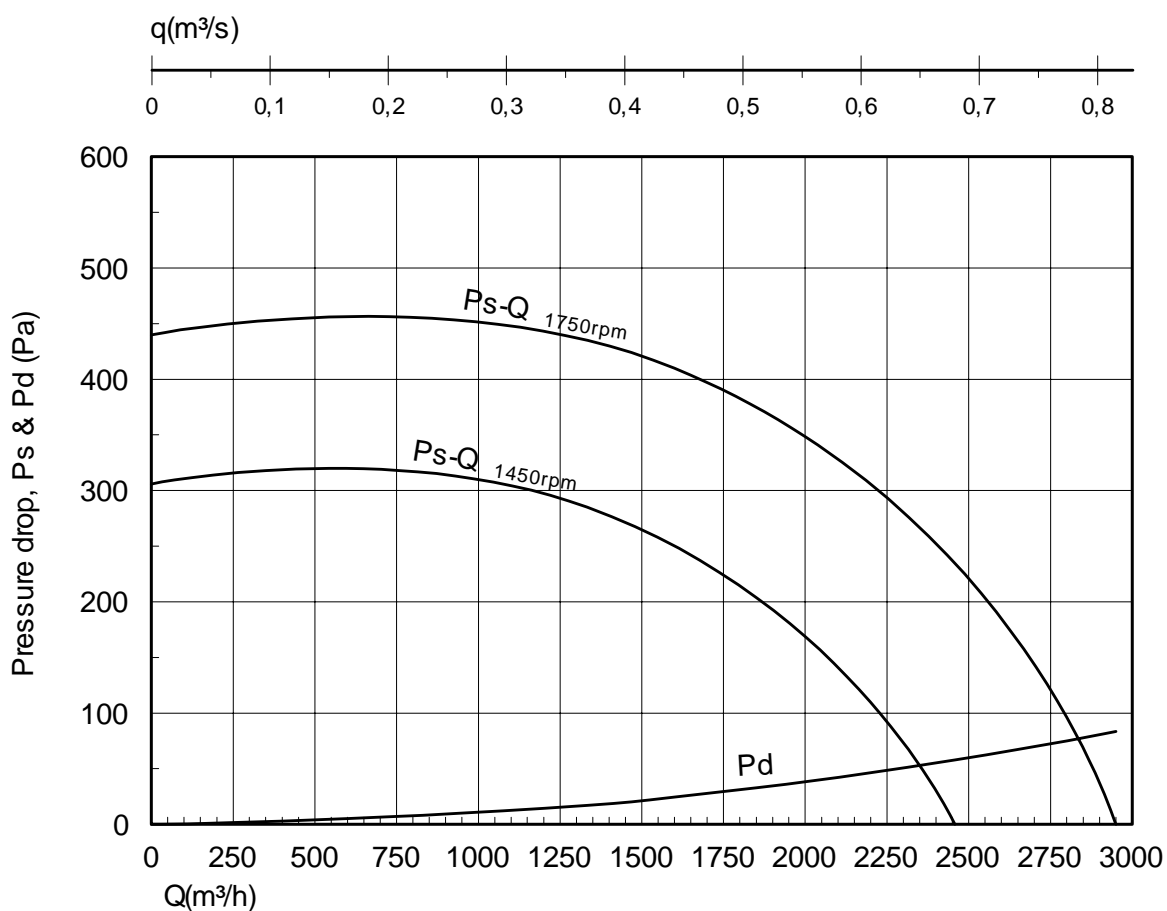

N Y B O R G A S

Nyborg17.prs/3

N-6230 SYKKYLVEN, NORWAY
TEL +47 70 25 40 80 - FAX +47 70 25 29 08
E-mail : office@nyborgfan.com - www.nyborgfan.com

SUV 300 Z



CENTRIFUGAL EXHAUST FAN PERFORMANCE DATA

SUV 350 B
Imp: 350x93

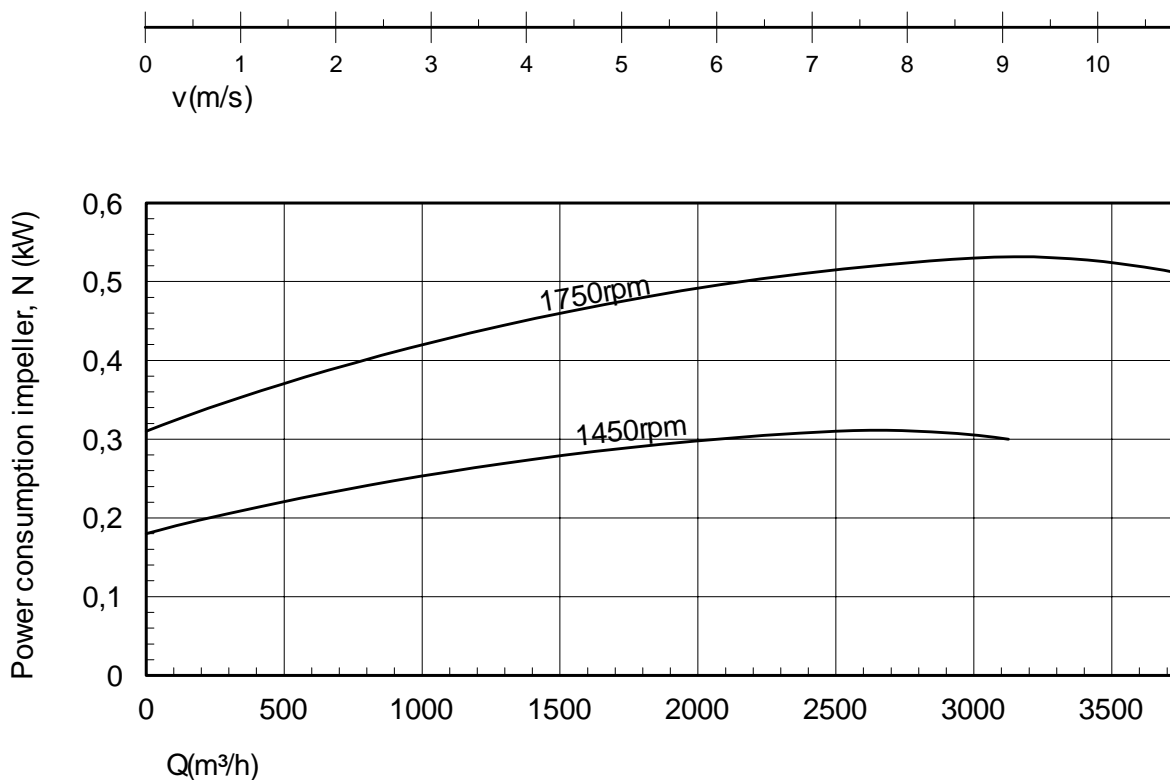
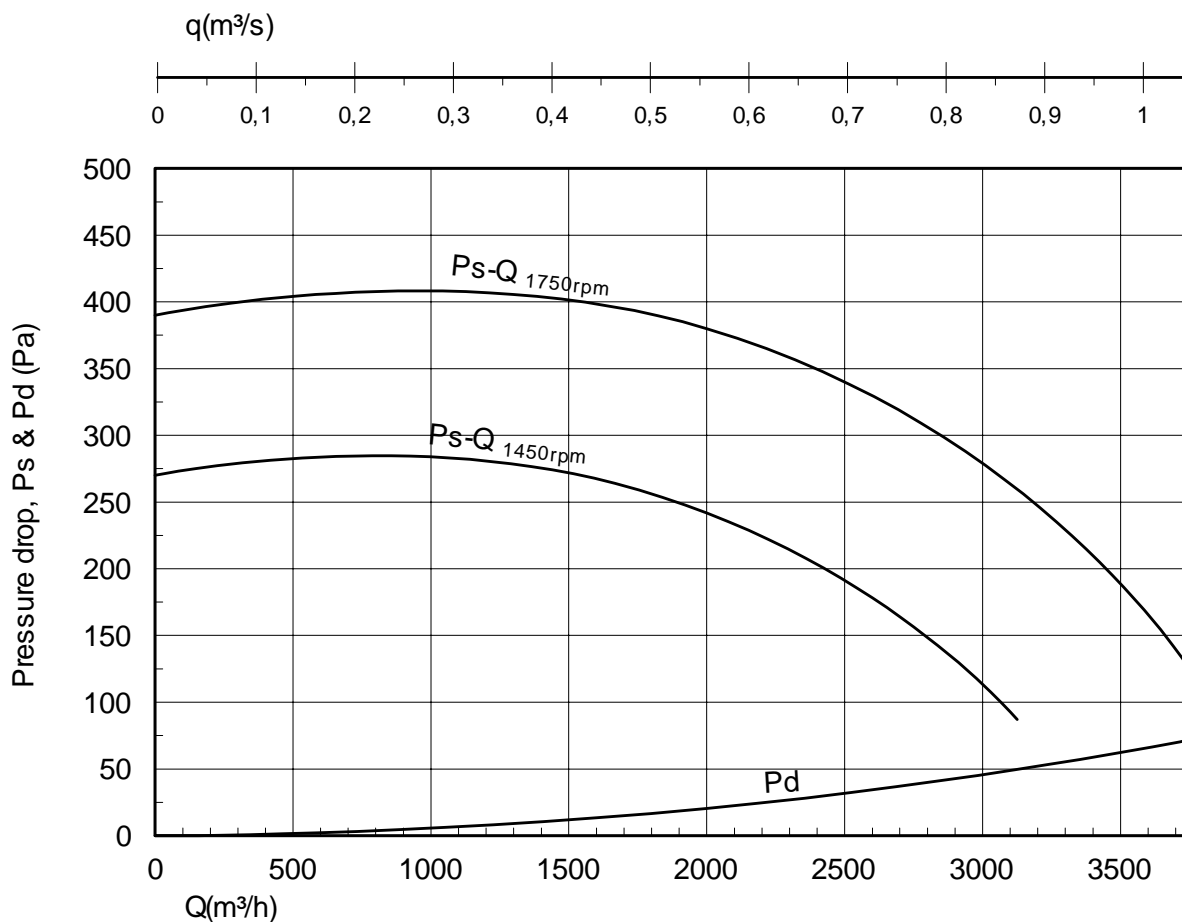

N Y B O R G A S

Nyborg17.prs/4

N-6230 SYKKYLVEN, NORWAY
TEL +47 70 25 40 80 - FAX +47 70 25 29 08
E-mail : office@nyborgfan.com - www.nyborgfan.com

SUV 350 B



CENTRIFUGAL EXHAUST FAN PERFORMANCE DATA

SUV 400 B
Imp: 400x105

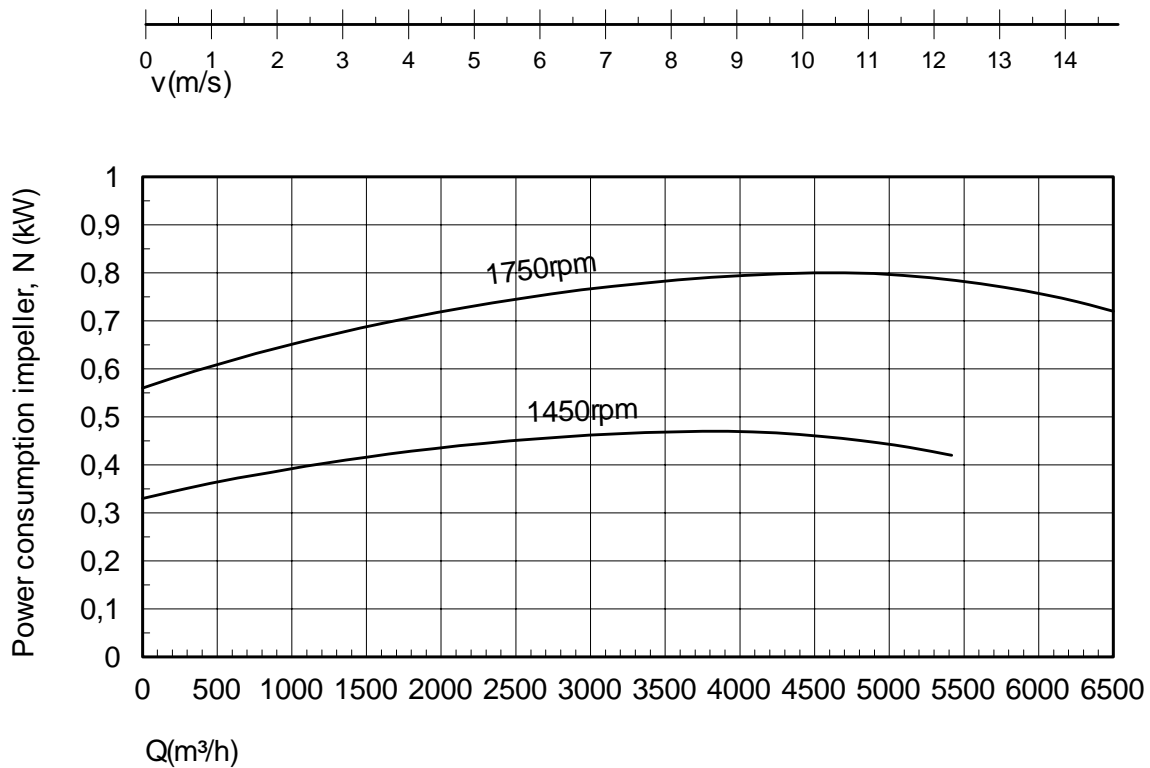
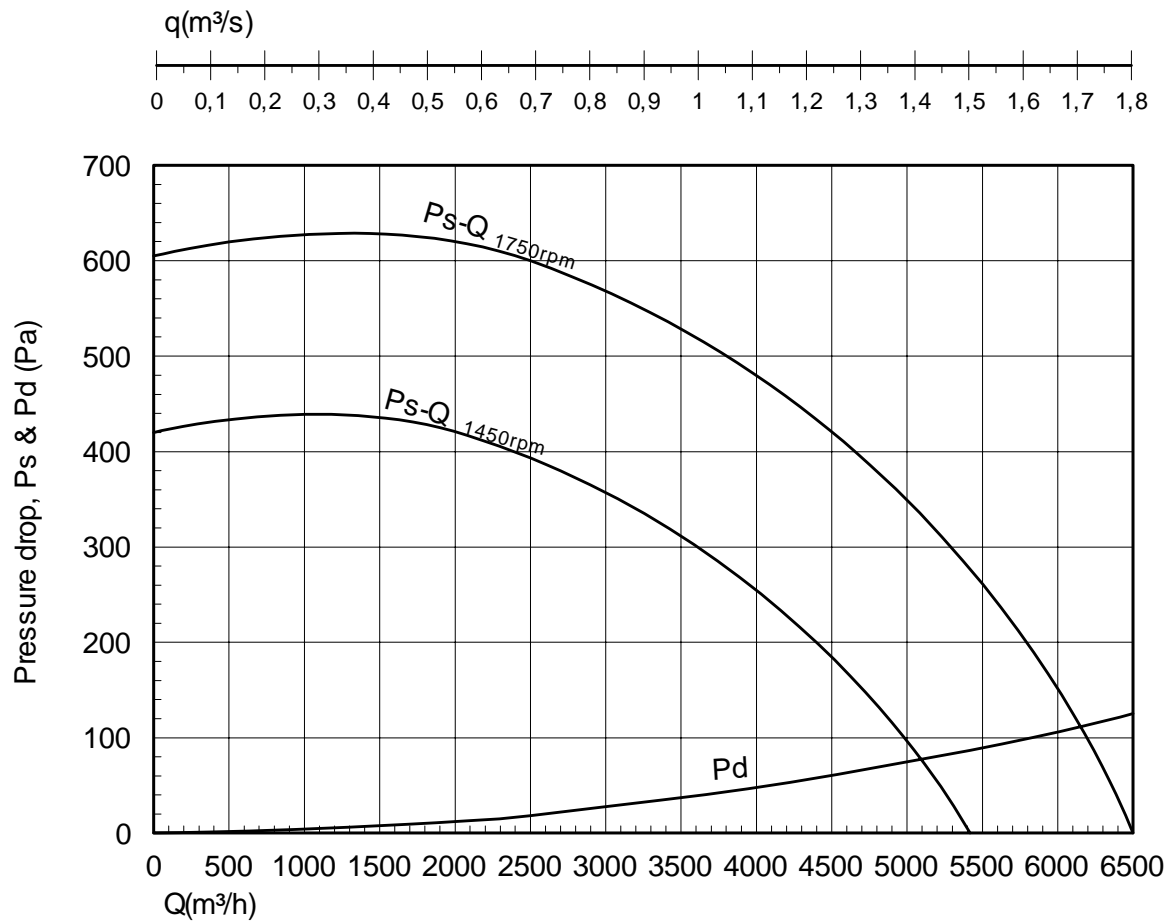

N Y B O R G A S

Nyborg17.prs/5

N-6230 SYKKYLVEN, NORWAY
TEL +47 70 25 40 80 - FAX +47 70 25 29 08
E-mail : office@nyborgfan.com - www.nyborgfan.com

SUV 400 B



CENTRIFUGAL EXHAUST FAN PERFORMANCE DATA

SUV 400 Z
Imp: Z12x400x105

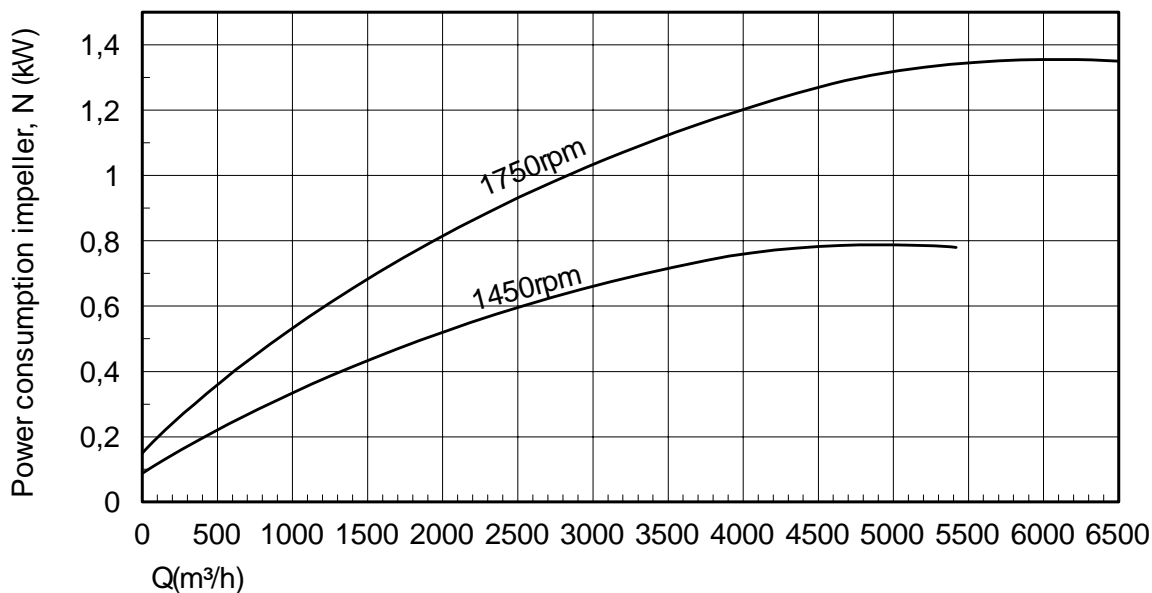
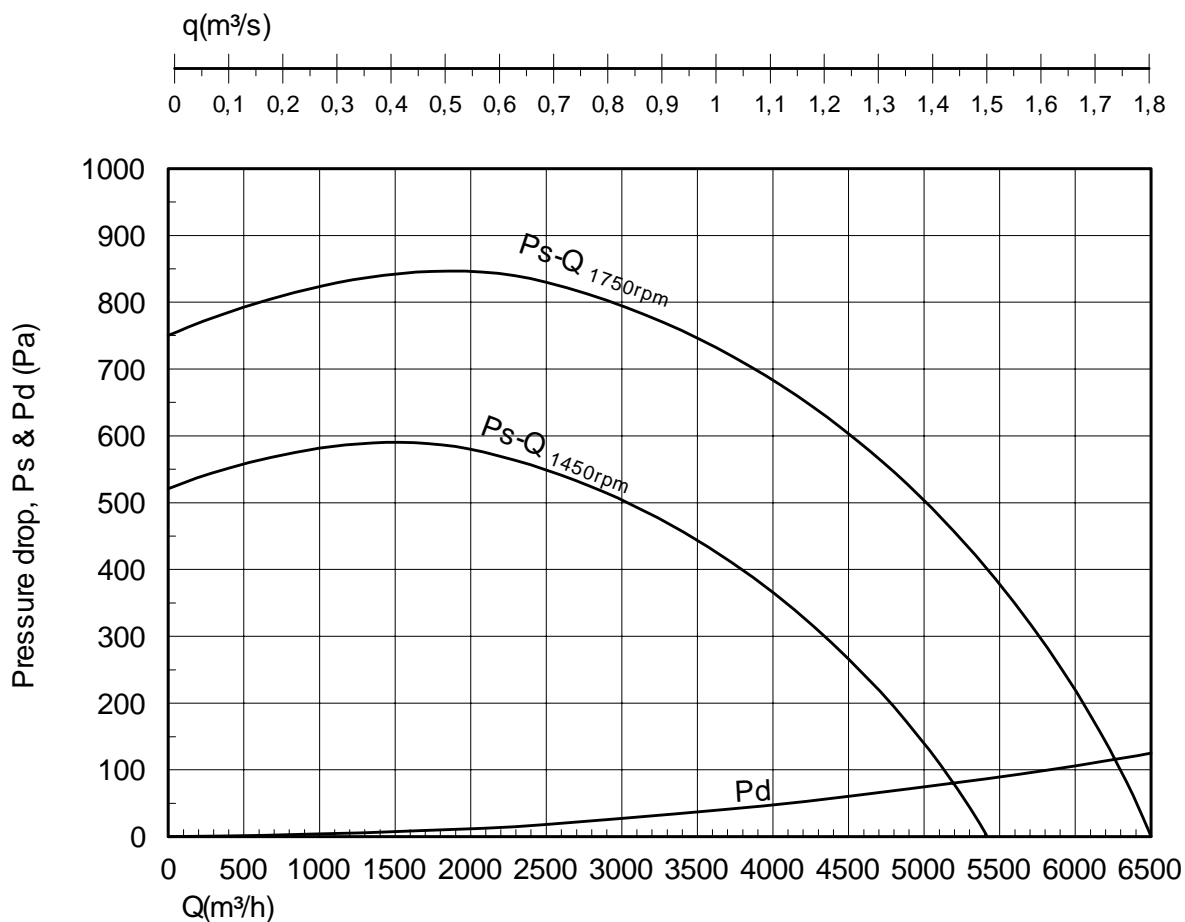

N Y B O R G A S

Nyborg17.prs/6

N-6230 SYKKYLVEN, NORWAY
TEL +47 70 25 40 80 - FAX +47 70 25 29 08
E-mail : office@nyborgfan.com - www.nyborgfan.com

SUV 400 Z



CENTRIFUGAL EXHAUST FAN PERFORMANCE DATA

SUV 450 Z
Imp: Z12x450x105

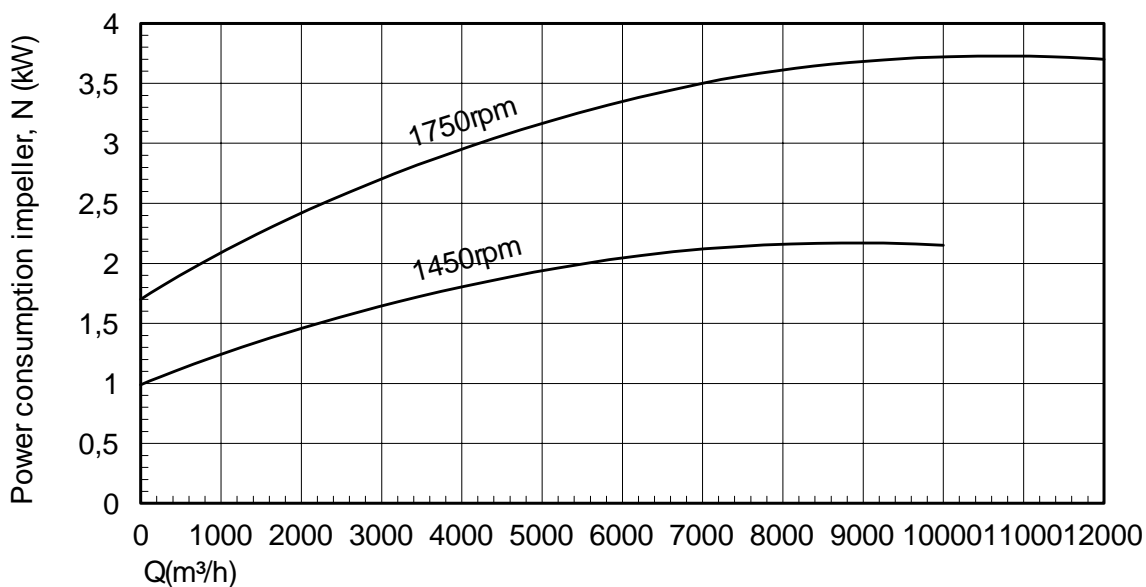
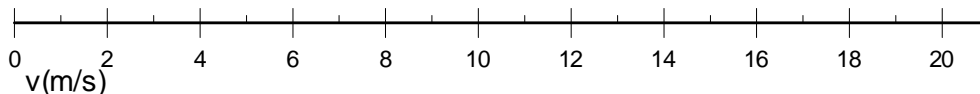
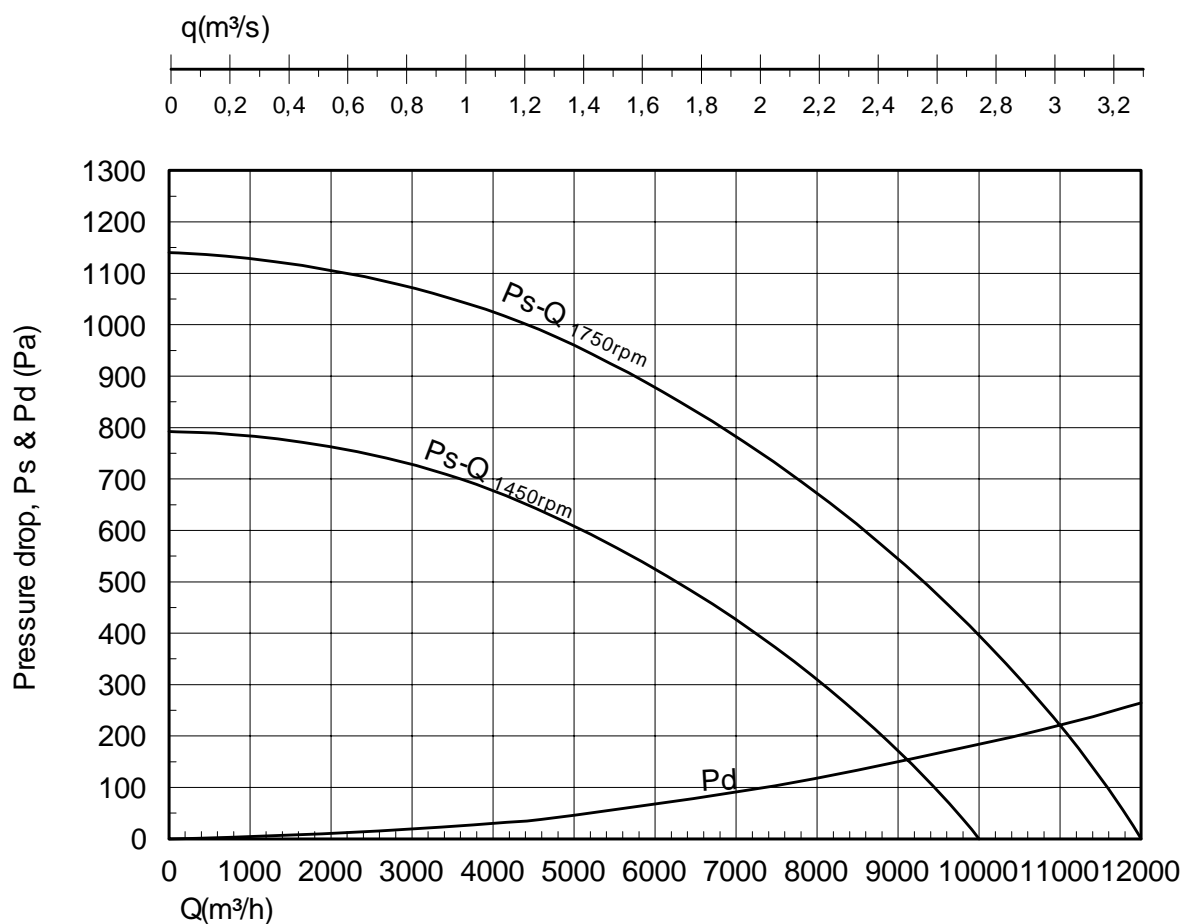

N Y B O R G A S

Nyborg17.prs/7

N-6230 SYKKYLVEN, NORWAY
TEL +47 70 25 40 80 - FAX +47 70 25 29 08
E-mail : office@nyborgfan.com - www.nyborgfan.com

SUV 450 Z



CENTRIFUGAL EXHAUST FAN PERFORMANCE DATA

SUV 500 B
Imp: B6x600x122

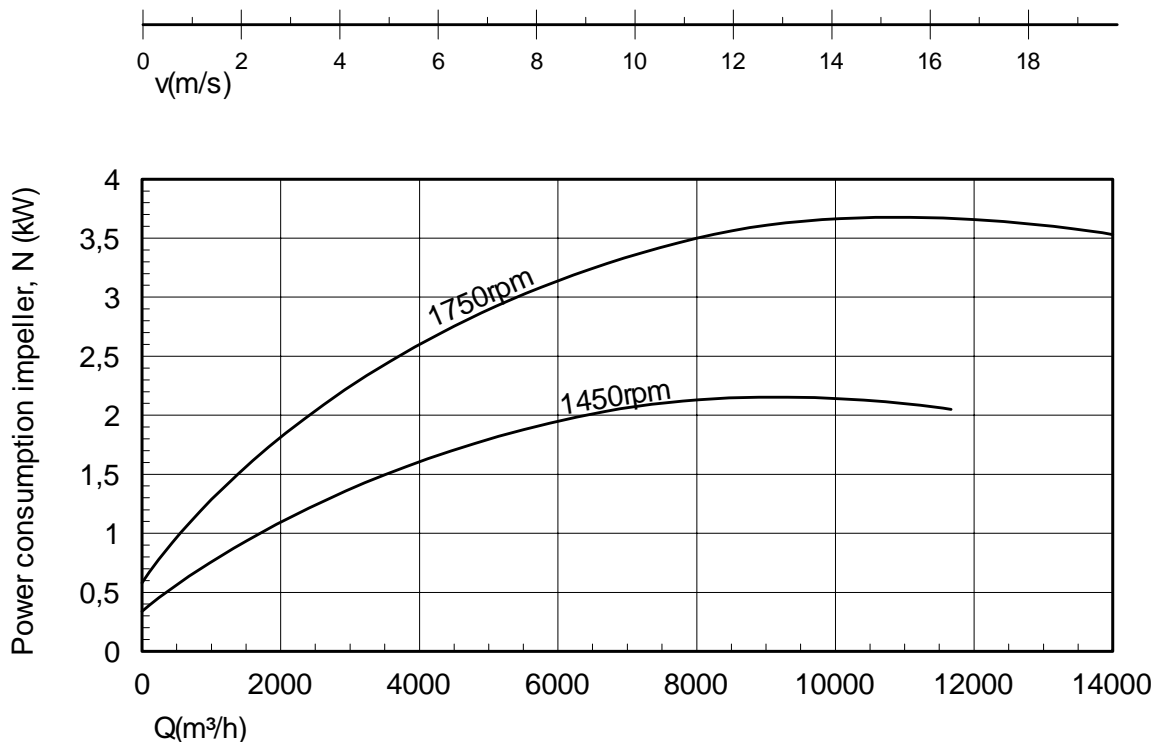
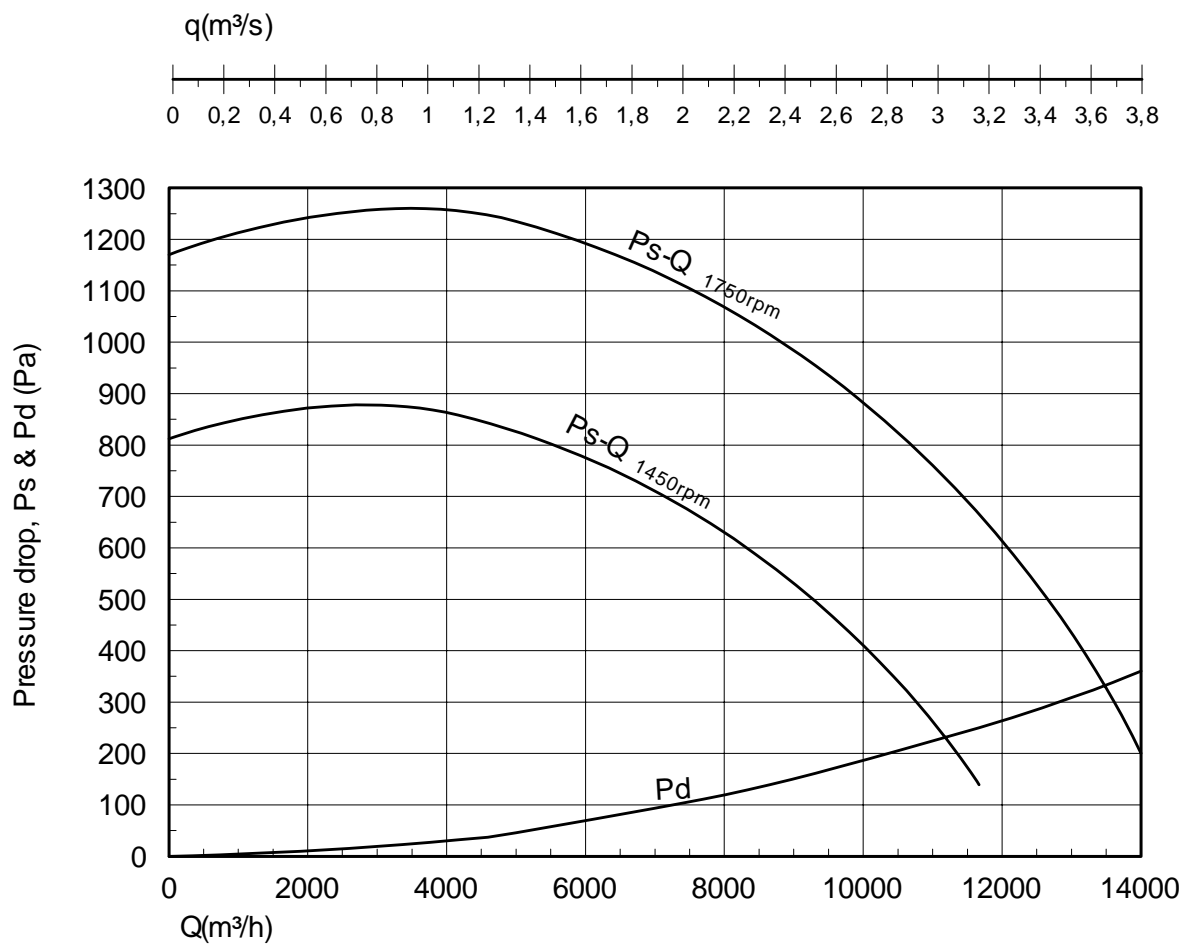

N Y B O R G A S

Nyborg17.prs/9

N-6230 SYKKYLVEN, NORWAY
TEL +47 70 25 40 80 - FAX +47 70 25 29 08
E-mail : office@nyborgfan.com - www.nyborgfan.com

SUV 500 B



CENTRIFUGAL EXHAUST FAN PERFORMANCE DATA

SUV 550 Z
Imp: 615x100

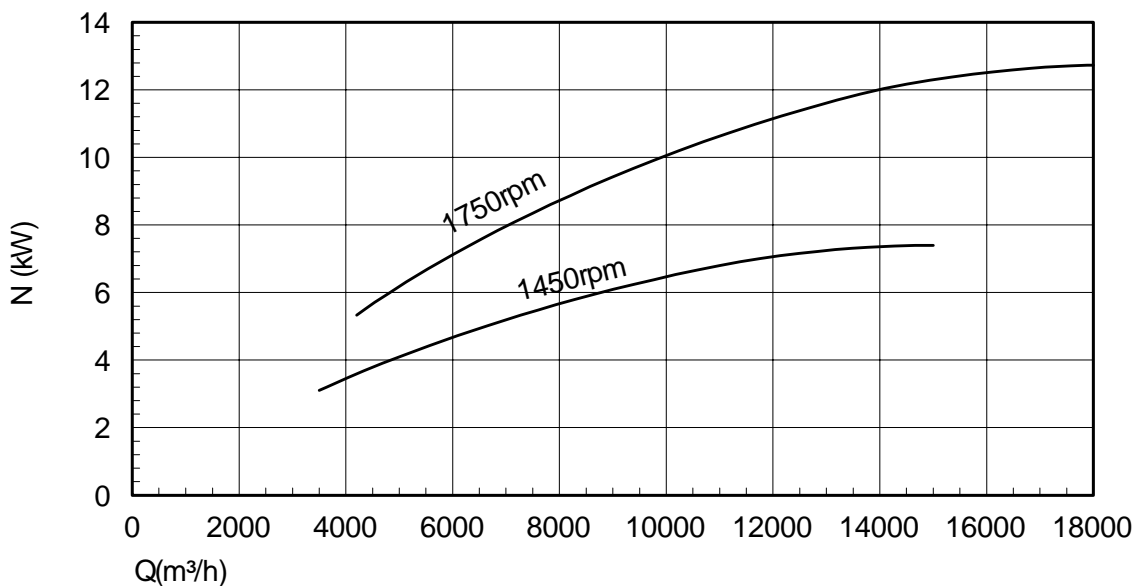
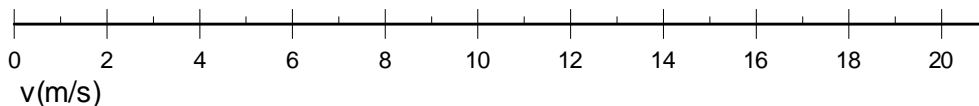
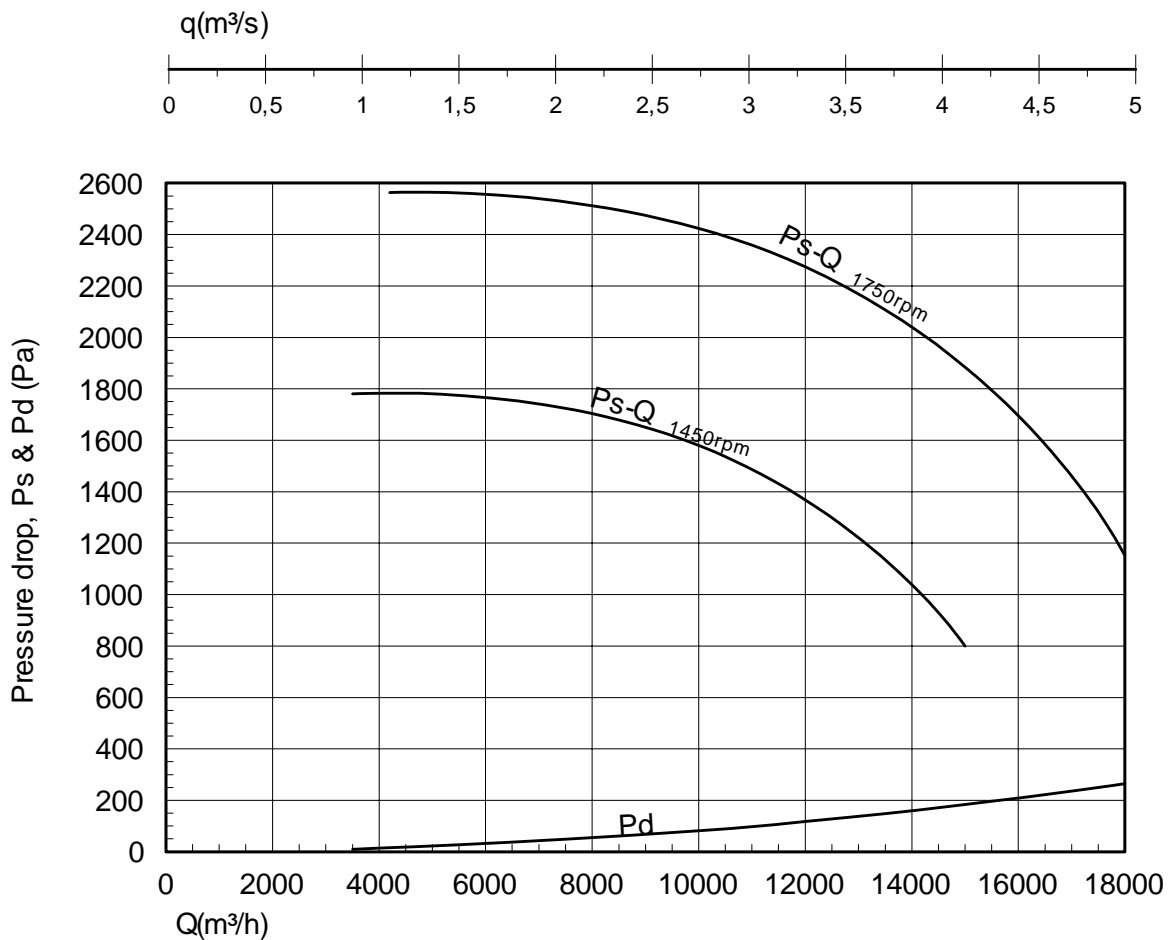

N Y B O R G A S

Nyborg17.prs/10

N-6230 SYKKYLVEN, NORWAY
TEL +47 70 25 40 80 - FAX +47 70 25 29 08
E-mail : office@nyborgfan.com - www.nyborgfan.com

SUV 550 Z