



LEAN PROPULSION



**SIMPLY THE BEST SOLUTION
FOR ANY FISHING VESSEL**



STADT LEAN PROPULSION®

Ship owners need reliable vessels that are efficient to operate, year after year, in all seasons and weather conditions. Most importantly, the ship must have a reliable propulsion system with propellers and power systems that never fail. One that enables them to operate safely anywhere on the planet. As a vendor of conventional PWM propulsion systems for many years, we asked the question: “Can a new way of thinking also give us a new generation of naval propulsion systems that are prepared for tomorrow’s environmental challenges” ?

STADT has taken these challenges seriously, when developing the STADT Lean Propulsion®, based on a completely different architecture – a truly revolutionary design.

A lean propulsion system that is amazingly reliable, and also reduces service costs, weight, fuel, emission and waste, while freeing up space.

A sophisticated and silent system with STEALTH performance, extremely long lifetime, and excellent manoeuvrability.

The new drive technology has been awarded several times for its unique characteristics, and many ships are now sailing with the Lean Drive technology all over the world.



Hallvard Slettevoll

Director, CEO

BE PREPARED FOR THE CARBON-NEUTRAL FUTURE

No electromagnetic interference, EMI, due to sine wave operation

No acoustic switching noises

No harmonic voltage distortion, THD, on the ship

No transformers for the propulsion are needed

No electric losses in the drives at normal operation

High redundancy in all levels of the drive systems

Major reduction of space and weight for the drives

Minimal need for cooling of drives and its systems

No need for screened power cables and cable segregation

Rugged and very well proven technologies

MTBF and lifetime improved dramatically compared to competitors

Simplified technology , 80 % reduction in number of components

COMPLETE SILENCE

BIGGER CATCH

HIGHER COMFORT

BETTER CREW WELFARE

STADT LEAN PROPULSION® - PATENTED TECHNOLOGY

Superior technology with Stealth performance. Ensures that the propeller never stops.

SUSTAINABLE, LEAN AND GREEN:

- Reduced fuel consumption, by slow steaming
- Only 6 % losses in systems (AC Motors and alternators included.)
- Reduced NOx, SOx, BC and CO2 emission
- Reduced maintenance and high redundancy
- Slow steaming optimized and lower EEDI

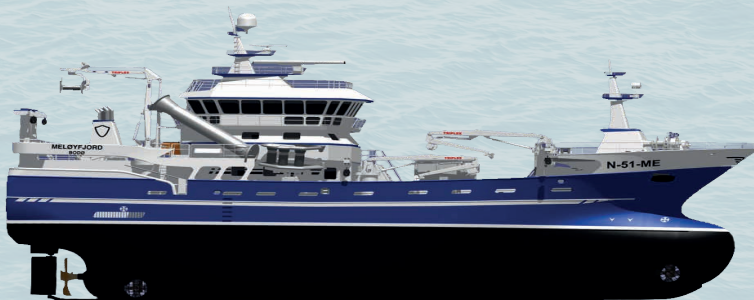

LEAN DRIVE FOR ANY SIZE OF SHIPS

EXPERIENCING THE **STADT LEAN PROPULSION**[®]

From MS HARTO - Purse Seiner

We installed the STADT diesel-electric propulsion in 2008 – now more than 10 years ago. It was a pioneer project, and many thought we were crazy - not using a main diesel engine. Over the 10 years of fisheries in the northern Atlantic, we have seen that the STADT-technology has given us a very robust ship that operates very silent by all means . Extremely low noise when we are searching for the fish, operating with only one genset instead of all the 4 that is in place. It gives a better catch, and we have a very high comfort onboard, in particular when we should go to sleep . The unique noise-free STADT technology does not disturb our sensitive fishing sensors.

It has also been a great advantage for us the redundancy built in to the system, from power generation through switchboard and electric propulsion motor drive arrangements. We have so far never been out of service, and STADT has helped us in an excellent way the very few times something needed to be serviced.



Tor Hugo Bergtun
MS HARTO ship owner

EVALUATION OF TODAY'S DIFFERENT DRIVE SOLUTIONS

Lean Issues To Consider	STADT Lean Drive	12 Pulse or 24 Pulse	AFE (Active Front End)
Technology in AC drive	Sine Wave	PWM	PWM
No. of electric energy transformations	0	4	4 or 5
Power Train Losses	No, (negligible)	6 %	6 - 7 %
Cooling Type	Air is sufficient	Water	Water
Power Transformers Needed	No	Yes	Sometimes• - - -
Redundant Power Units	Standard	Special	Special
Harmonic Distortion (THD)	No	High	High
Electromagnetic Interference	No	High	High
Acoustic Switching Noise	No	Yes	Yes
Screened Power Cables needed	No	Yes	Yes
Depending on Harmonic Filters	No	Yes	Yes
Designed Economic Lifetime	30 Years	6 Years	6 Years
Maintenance Requirement	Very Low	Frequent	Frequent
Onboard Crew Skills	Ordinary	Special	Special
MTBF (mean time between failures)	7 Years	1 Year	1 Year
MTTR (mean time to repair)	1 Hour	1 Week	1 Week
Spares Globally Available	Yes	No	No
Weight of Drive System	100 %	1100 % - 1400 %	600 % - 1600 %
Size of Drive System	100 %	500 % - 600 %	450 % - 700 %
All Voltage Class (220V-15kV)	Yes	No	No
Power Scalable	Yes	No	No
Regenerates Power to Grid	Yes	No	Yes
No. of Power Components in Line	1	80 000	150 000
Capacitors In Main Power Circuit	No	Yes	Yes
Explosion Risk in Drive	No	Yes	Yes
Propeller Pitch Configuration	CP	CP or FP	CP or FP
Financial Risk (Service cost, Off-hire)	Very Low	High	High

TECHNOLOGY DIFFERENCES

STADT LEAN PROPULSION® TECHNOLOGY

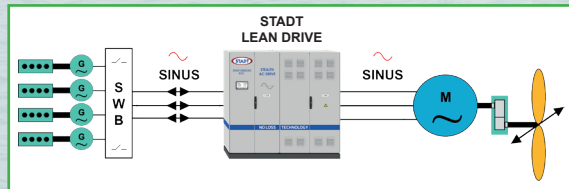

STEALTH

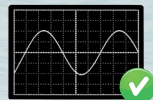

SINE WAVE IS NOISE FREE,
NO EMI

COMPETITOR PWM DRIVE TECHNOLOGY

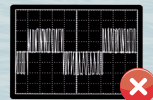
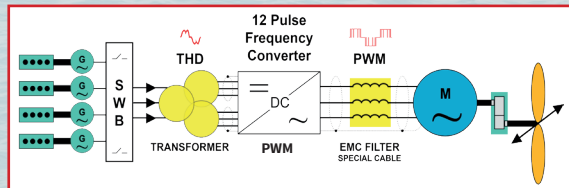

PWM CREATES A LOT
OF EMI AND ACOUSTIC
SWITCHING NOISE

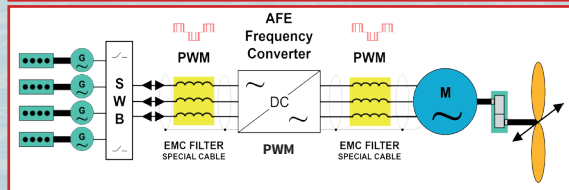

THE DIFFERENCE:



LEAN DRIVE -PATENTED-

SWB

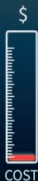
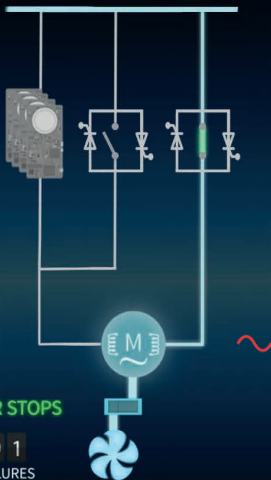

COMPLEX PWM DRIVE

SWB

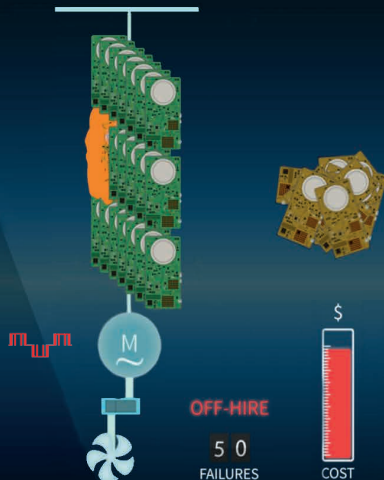

See our animated film at www.STADT.no

DISCOVER THE POWER OF SIMPLICITY

ELIMINATED:

- POWER DISTURBANCE THD ON GRID
- HARMONIC FILTERS
- 12 P - 24 P TRANSFORMER
- NOISE (PWM→EMI)
- EXPLOSION RISK (CAPACITORS)
- 80.000 COMPONENTS
- COOLING SYSTEMS
- 5-6 % WASTED HEAT
- COMPLEXITY

= **LESS OFF-HIRE**

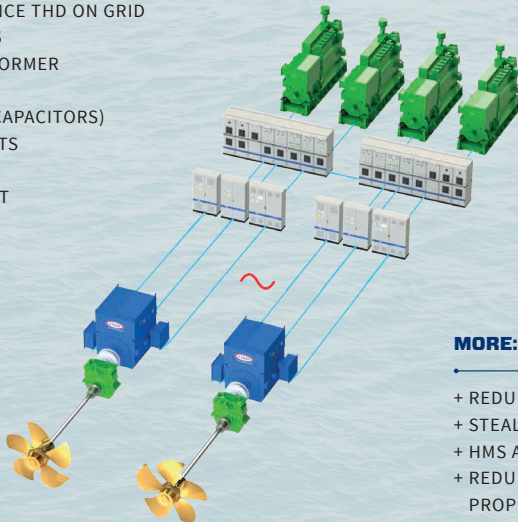

STADT LEAN PROPULSION®

MORE:

- + REDUNDANCY IN DRIVE
- + STEALTH
- + HMS AND COMFORT (SILENCE)
- + REDUNDANCY, ALSO IN AC PROPULSION MOTORS
- + POWER TO PROPELLER

= **BETTER PERFORMANCE**

COMPLEX PWM DRIVES (for comparison)

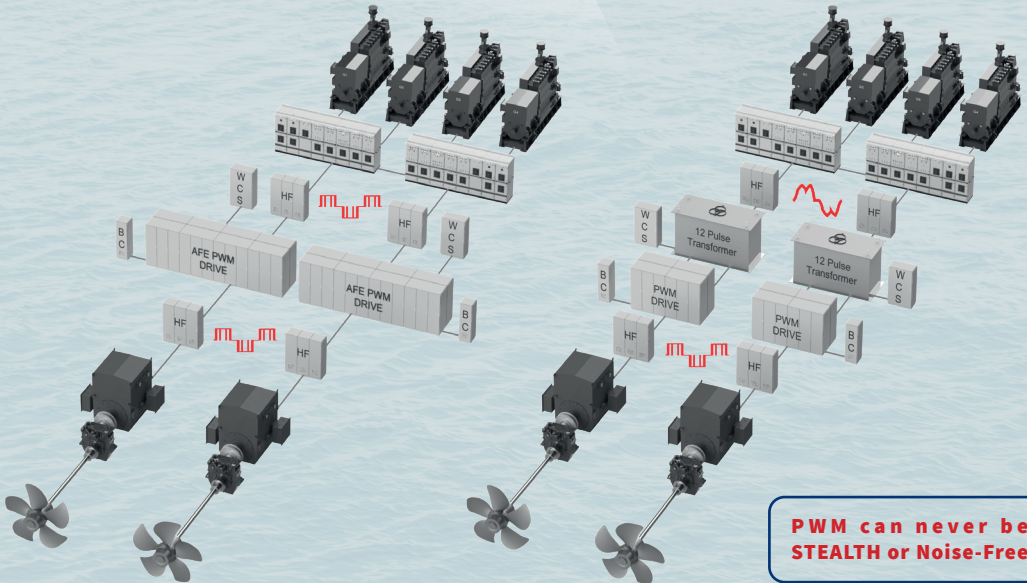

AFE PWM

12 OR 24 PULSE PWM

**PWM can never be
STEALTH or Noise-Free**

STADT LEAN PROPULSION® REFERENCES



Seihav

WELL-BOAT

Diesel-electric Propulsion

Thrusters Drive System



Meløyfjord

Purse Seiner

Diesel-electric Propulsion

Thrusters Drive System



Voldnes

Purse Seiner

Diesel-electric Propulsion

Thrusters Drive System



Harto

Purse Seiner

Diesel-electric Propulsion

Thrusters Drive System



Hepsøhav

Purse Seiner

Thrusters Drive System



Sjøglans

Purse Seiner

Thrusters Drive System



Hovden Viking
Purse Seiner
Thrusters Drive System



Slettholmen
Purse Seiner
Thrusters Drive System



Solværskjær
Purse Seiner
Thrusters Drive System



Sildaskjær
Purse Seiner
Thrusters Drive System



Bernt Oskar
Purse Seiner
Thrusters Drive System

**See www.STADT.no
for more references**

WHY WE USE CPP - CONTROLLABLE PITCH PROPELLER

THE PATENTED STADT LEAN DRIVE COMBINES PITCH AND RPM-CONTROL

- Significantly improved overall efficiency at varying load and/or varying speed conditions
- Better manoeuvrability (acceleration, breaking, crash stop)
- Better performance at reversing and in DP
- Better operational conditions for gear, shaft, and bearings, especially at low speed
- Forgiving for design errors
- Each blade may be changed independently if damaged, at sea
- Future-proof with regard to changes of use of the vessel, slow steaming, extensions, etc.
- Possibility for full feathering position, which is saving fuel when only running one propeller



STADT HYBRID

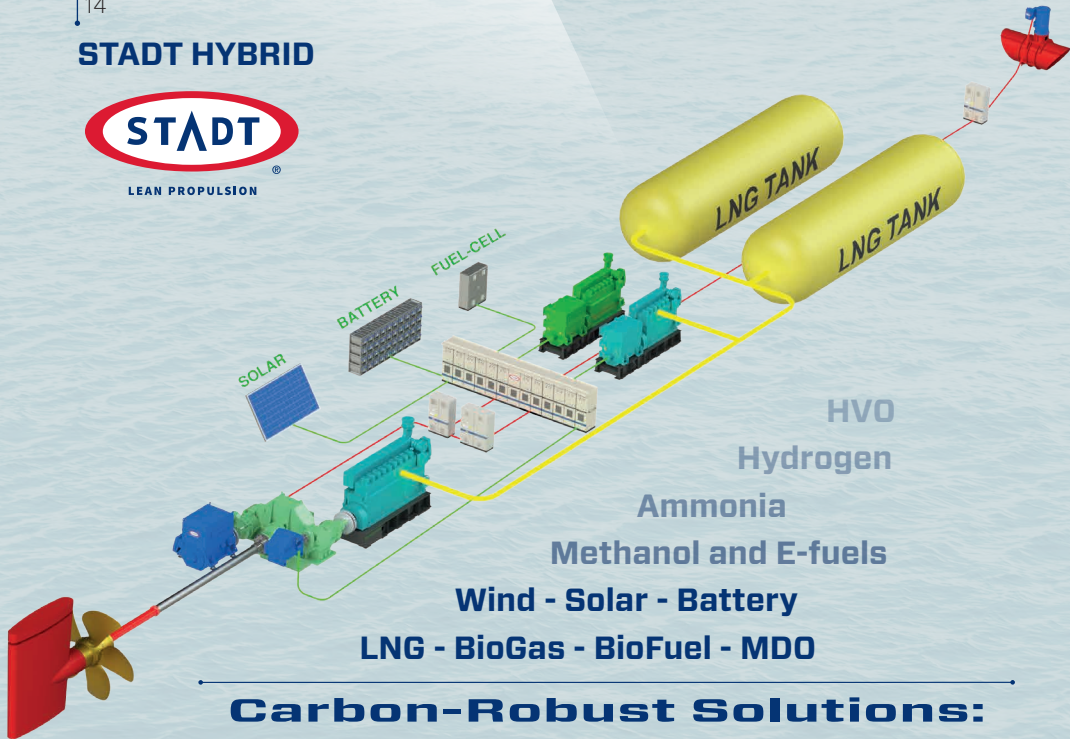

HVO

Hydrogen

Ammonia

Methanol and E-fuels

Wind - Solar - Battery

LNG - BioGas - BioFuel - MDO

Carbon-Robust Solutions:

STADT LEAN PROPULSION® ARRANGEMENTS - IEP

SOME BASIC ARRANGEMENTS FOR FULL ELECTRIC PROPULSION, BASED ON DIESEL, LNG OR BIO FUELS

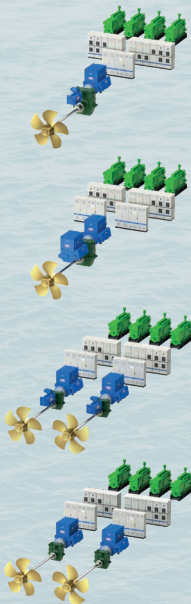

Single screw PTI, CP

- 4 generators
- 2 electric motors, big and smaller
- 2 main switchboards

Single screw Twin, CP

- 4 generators
- 2 electric motors
- 2 main switchboards

Twin screw PTI, CP

- 4 generators
- 4 electric motors, big and smaller
- 2 main switchboards

Twin screw, CP

- 4 generators
- 2 electric motors
- 2 main switchboards

STADT - YOUR SYSTEM INTEGRATOR

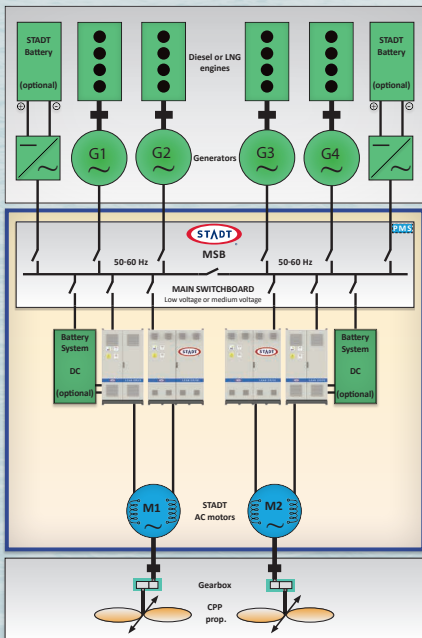

**LET US DESIGN YOUR NEW
SUSTAINABLE PROPULSION
SOLUTION**

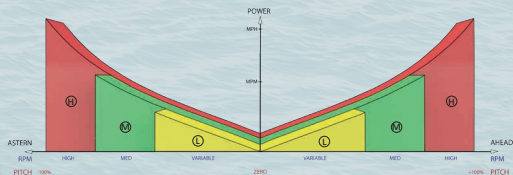

THE STADT SCOPE

Delivered to meet any typical ship classification standard.

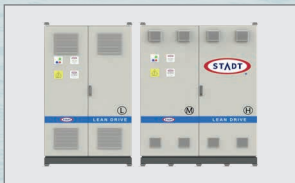

STADT Lean Drives. Scalable in power to more than 50 MW per propeller.



STADT AC motors, a broad range.



STADT main switchboards, MCC, low voltage and medium voltage.



STADT power generators, battery systems, shore-to-ship power solutions, distribution transformers, etc.

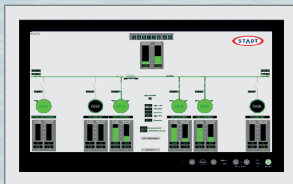

Power Management System (PMS), IAS, remote access from shore, Dynamic Positioning (DP).

SERVICES and EPC:

- Engineering of propulsion solutions
- Manufacturing and installation
- Commissioning
- Global Services

STADT - AWARDED TECHNOLOGY LEADER

The STADT Group was founded by Hallvard L. Slettevoll in 1985. We are located in the new and modern STADT Maritime Center in Gjerdsвика harbour.

For many years STADT has been a leading company in AC drive innovations. Long experience from development of motor drives has resulted in the patented STADT Lean Drive technology. This has huge advantages compared to traditional PWM-technology, since it is free from electric disturbances. The STADT Lean Drive is also a very efficient



power drive system, bringing reliability up to a new standard.

The first STADT electric propulsion delivery went to the Norwegian coastguard K/V Tromsø in 1996, representing a technological breakthrough.



The Lean Drive was patented in 2008, and launched to the first ship applications the same year. The new drive technology has been awarded several times for its unique characteristics, and many ships are now sailing with the Lean Propulsion® technology all over the world.

STADT HISTORY



35 YEARS IN AC DRIVE DEVELOPEMENT

LEAN BRINGS YOU

+ SAFETY & RELIABILITY
+ VERY LONG LIFETIME

+ STEALTH & HSE
+ MORE CARGO CAPACITY

+ LESS EMISSION AND FUEL
+ COST EFFICIENCY

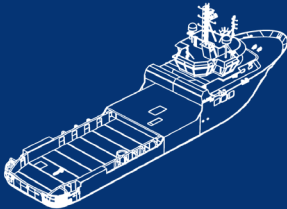

STADT AS
Moljevegen 50 | N-6083 Gjerdsvika | Norway
Tel.: +47 700 25 800 | www.stadt.no

